

ZIVA[®]



**EUROPEAN
COMMERCIAL**

CONTENTS

INTRODUCTION

| | |
|------------------------------|----|
| About | 04 |
| ZIVA: Past and Present | 06 |
| ZIVA Training Club | 08 |
| Commitment to Sustainability | 10 |
| Commercial Intro | 12 |

INFINITY

| | |
|--------------------------------------|----|
| INFINITY Wall Mounted Modular System | 17 |
| INFINITY Bridge | 24 |
| INFINITY Training Tower Bridge | 29 |
| INFINITY Wall Corner | 35 |
| INFINITY Training Tower | 38 |
| INFINITY Removable Accessories | 41 |
| INFINITY Rubber Mat | 42 |

FREE WEIGHTS

| | |
|---|----|
| ZVO Solid Steel Urethane Dumbbells | 55 |
| ZVO Solid Steel Urethane Barbell/EZ Curl Barbell | 56 |
| ZVO Solid Steel Urethane Dumbbell | 59 |
| ZVO Urethane Functional Tribell | 62 |
| ZVO Urethane Grip Discs | 63 |
| SL Urethane Dumbbells | 66 |
| SL Urethane Barbells/EZ Curl Barbells | 68 |
| SL Solid Steel Head Urethane Dumbbell with Urethane Grips | 70 |
| SL Urethane Hexagon Dumbbells | 72 |
| XP Urethane Dumbbells | 80 |
| XP Urethane Barbells/EZ Curl Barbells | 84 |
| SL RPU Dumbbells | 91 |
| SL RPU Barbells/EZ Curl Barbells | 96 |
| SL RPU Grip Disc | 98 |
| SL Urethane Grip Disc | 99 |

BENCHES

| | |
|---|-----|
| EX Benches 2.0 | 106 |
| EX Olympic Benches | 114 |
| Multi-Grip Knee Raise/Dip/Pull-up Station | 121 |
| Hip Thrust Station | 122 |

STORAGE

| | |
|---|-----|
| EX Horizontal Dumbbell Racks 2.0 | 130 |
| EX 10-Piece Barbell Rack 2.0 | 132 |
| EX Disc Storage Station 2.0 | 133 |
| EX 1 - 10kg Vertical Studio Dumbbell Rack 2.0 | 136 |
| EX Functional Wall Storage | 138 |
| ST 10-Pair X-Brace Dumbbell Rack | 139 |
| ST Horizontal Dumbbell Racks | 140 |
| ST Barbell Racks | 142 |
| ST Disc Storage Rack | 145 |
| ST Studio Dumbbell Racks | 146 |
| ST2 Hexagon Dumbbell Rack | 148 |
| XP Dumbbell Racks with Saddles | 152 |
| XP Barbell Racks | 158 |
| XP Plate Tree (18 pieces) | 162 |
| XP Modular Storage Rack System | 166 |
| XP 4-Tier Storage Racks | 170 |

BUMPERS AND OLYMPIC BARS

| | |
|---|-----|
| ZVO Urethane Competition Colored Bumper Discs | 182 |
| ZVO Rubber Competition Colored Training Bumper Disc | 183 |
| SL Black Urethane Competition Bumper Disc | 185 |
| SL Rubber Competition Colored Training Bumper Disc | 187 |
| SL Rubber Competition Black Training Bumper Disc | 189 |
| XP2 Rubber Black Bumper Disc | 192 |
| XP Bumper Storage Rack | 194 |
| ZVO Olympic Bars | 202 |
| Specialty Olympic Bars | 206 |

POWER RACKS

| | |
|--|-----|
| XP Power Rack with Storage | 216 |
| XP Small Foot Print Half Rack with Storage | 218 |
| XP Half Rack with Storage | 222 |
| XP Wall Mounted Half Rack | 224 |
| XP Squat Rack | 226 |
| XP Half Rack Cable | 228 |

XP WALL SYSTEM

| | |
|---------------------------|-----|
| XP Wall System | 240 |
| XP Cable Wall Attachments | 261 |

RIGS

| | |
|--|-----|
| XP Cable Rig | 268 |
| XP Half Rack Rig | 269 |
| XP Cable Station | 270 |
| XP Freestanding Space Saving Rigs | 274 |
| XP 9' High Self-Supported Modular Rigs | 284 |
| XP 9' High Wall-Mounted Modular Rigs | 285 |
| XP Space Saving Wall-Mounted Rigs | 287 |
| XP 9' 4 Shelves Storage System | 288 |
| XP Rig Attachments | 290 |
| ZVO Urethane Cable Attachments | 294 |
| XP2 Floor-Mounted Functional Rack | 298 |
| XP2 Attachments | 303 |

FUNCTIONAL

| | |
|---|-----|
| EX Functional Training Station | 310 |
| XP Functional Corner | 311 |
| EX Functional Stretch Station | 312 |
| EX Functional Benches | 316 |
| ZVO Medicine Ball 2.0 | 320 |
| ZVO Slam Ball | 324 |
| ST Multi-Ball Trees | 326 |
| ZVO Premium Wall Ball 2.0 | 332 |
| ZVO Premium Power Core Bag 2.0 | 333 |
| XP Wall Ball Pro | 336 |
| XP Wall Ball Pro | 337 |
| PowerWave | 340 |
| ST Functional Accessories Storage Racks | 342 |
| Signature Steel Competition Kettlebells by Steve Cotter | 346 |
| EX Kettlebell Rack 2.0 | 347 |
| SL Virgin Rubber Kettlebell | 349 |
| ST Kettlebell Rack | 350 |
| SL TYRE X | 352 |
| Plyo Boxes | 353 |
| XP Power Sled 2.0 | 362 |
| Battle Ropes | 363 |
| ZVO Anti-Burst Core-Fit Ball | 364 |
| Core Fit Ball Storage Racks | 366 |
| Yoga Mats | 370 |
| XP Balance Ball | 372 |
| Pro FT Step | 377 |

STUDIO

| | |
|---|-----|
| Performance RPU Hexagon Dumbbell | 382 |
| Performance Hexagon Dumbbell Racks | 383 |
| Neoprene Dumbbells | 388 |
| 1-10kg Studio Dumbbell Rack | 389 |
| Performance Competition Kettlebell | 390 |
| Performance Kettlebell Storage Rack | 391 |
| Performance Olympic Bars | 394 |
| Performance Half Rack | 400 |
| Performance Slam Ball | 401 |
| Performance Medicine Ball | 402 |
| Performance Medicine Ball/Slam Ball Storage Trees | 404 |
| Performance Power Twist Bag | 408 |
| Performance Power Sand Bag | 409 |
| Performance Storage Trees | 410 |
| Performance 4-Tier Universal Storage Rack | 414 |
| Performance 3-Tier Ball Storage Rack | 415 |
| Performance PLUS 4-Tier Storage Rack with Wheels | 416 |
| Performance Studio Barbell | 420 |
| Performance Cable Attachments | 422 |
| Studio Mat Rack with Casters | 426 |
| Performance Core-Fit Ball | 430 |
| Performance Sled | 432 |
| Performance Bodyweight Trainer System | 433 |
| Performance Plyo Boxes | 436 |
| Performance Battle Rope | 439 |
| Performance Accessories | 440 |





ZIVA® is an elite-performance sports and wellness brand. Distilled to its essence, our brand is driven by the peace of harmony and the joy of living, expressed most powerfully for us through sport, movement, and strength. This essential drive underpins our efforts to improve the physical and mental health of people all around the world.

This philosophy is reflected in our name. The “ZI” in ZIVA comes from the name of the founder of Daoism, an ancient Eastern religion that emphasizes harmony; living in accord with both the nature around you, and with your own nature; and cultivating an attitude of gratitude and happiness by following what it refers to as “The Way.” The “VA” in ZIVA is the second half of the Spanish word “viva,” which means to live fully, to strive with all your heart, and which is an exclamation proclaiming the absolute joy of life and all that it entails.

Our philosophy is embodied in our products. Their premium, progressive design is made to exist in beautiful, artful harmony with high-class gyms and modern homes while their rugged, high-performance functionality invites movement and energetic exertion.

And our philosophy is lived by every team member every day as we work in harmony with one another, joyously striving to bring holistic fitness to the world.

This is ZIVA and our WAY TO LIVE.

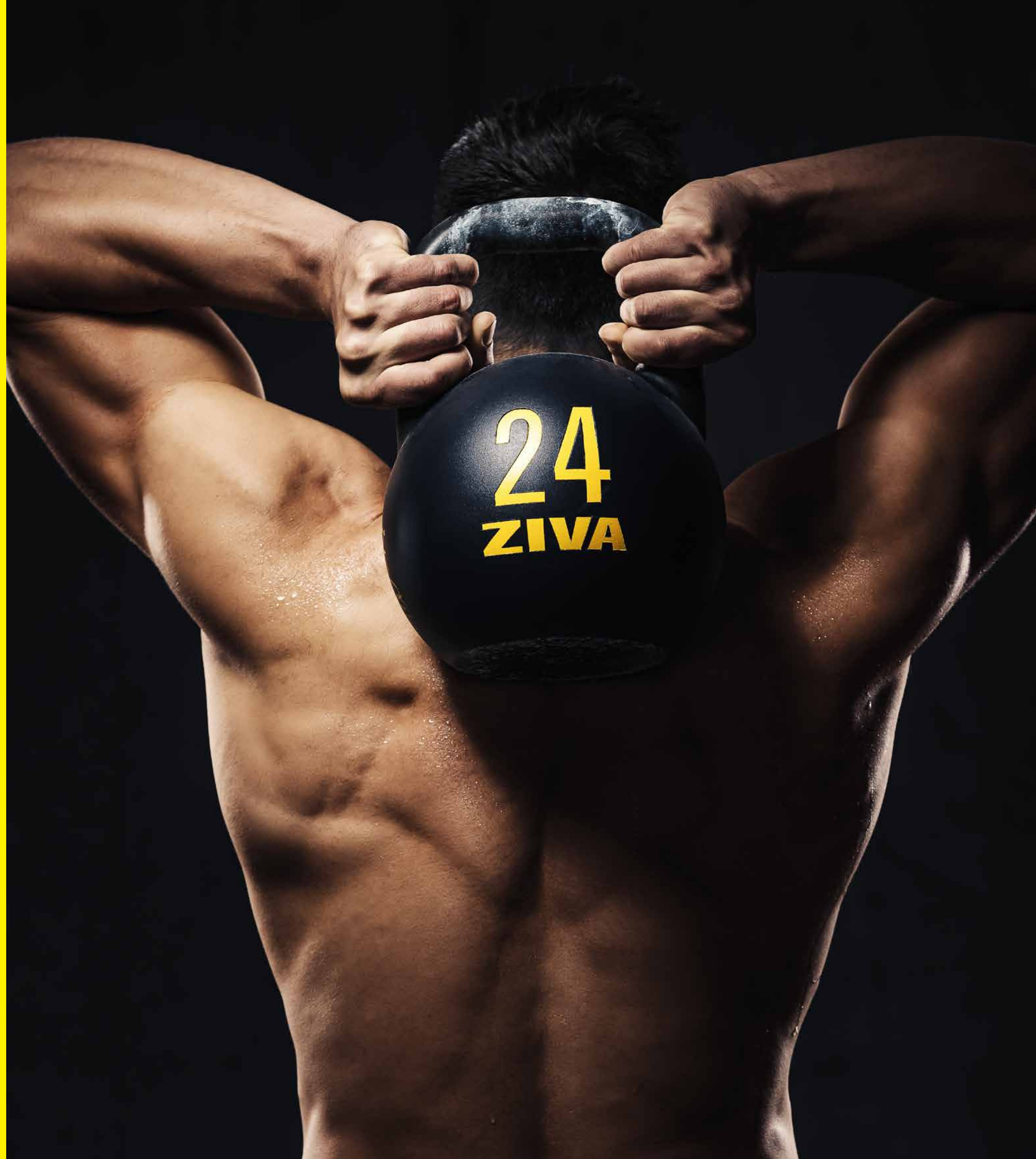

ZIVA: PAST AND PRESENT

The ZIVA® Journey began in 2008 in a single, out-of-the-way gym from our earliest days, we sought to provide athletes and fitness enthusiasts with a transformational platform that could empower their fitness journey.

The things we practiced in the gym forged the values at the core of our company: innovation, inspiration, and precision. Our business has changed radically over the past decade and a half; today we create commercial products tailor-made for the world's most recognizable gym brands and craft gorgeous exercise equipment especially made for the at-home athlete. We still have that out-of-the-way gym, but it's now part of a global corporation where we design, manufacture, market, and ship over 1,000 SKUs in over 80 markets.

And though we have grown, the values we first forged in the gym are still with us, now embodied in our innovative solutions, inspirational designs, and precision manufacturing. Our team of powerful, passionate, and positive people has grown many times over, but still all practice the ZIVA Way to Live.



ZIVA TRAINING CLUB

At ZIVA®, our aim isn't just to grow a fitness business, it's to build a fitness legacy that ensures the future vitality of the industry we love so much. That's why we invest so heavily in high quality content, including exciting, engaging instruction for at-home athletes, and elite-level professional education and programs for the fitness pros using our equipment in commercial settings every day to improve the lives of those they train.

The ZIVA Training Club is a constantly growing worldwide collaboration of top-level trainers, innovators, and competitors making training content that uses proven methodologies, science-based programming, and fantastic production values that deeply engage athletes at all levels. Curated by our Director of Education, the content found here features professional ZIVA trainers, brand ambassadors, and presenters who deliver world-class training that turns every viewer into a VIP client.

ZEL ZIVA EXERCISE LIBRARY

This yellow icon identifies home and commercial products featured in the ZIVA Exercise Library. The ZIVA Exercise Library is an online database of exercise demos and tutorials built around ZIVA kit to inspire fresh approaches to exercise while mitigating unnecessary risk of injury.

ZEP ZIVA EXERCISE PROGRAMMING

The gray ZEP icon marks home and commercial products featured in programmed exercise templates built to guide enthusiasts and trainers through sample workouts and routines. ZIVA Exercise Programming content may be presented in printed or video formats.



ZIVA® AND THE COMMITMENT TO SUSTAINABILITY

Since our very inception, the ZIVA vision of wellness has been holistic, comprising not only mental, physical, and spiritual health, but the health of the world around us, as well. We have lived our commitment to sustainability from the first ZIVA showroom – One Wellness – which was designed to be carbon neutral all the way back in 2008. It was the very 1st carbon neutral gym in Asia, and the 2nd in the world. Before many had heard of carbon neutrality, it was a personal point of pride for us and a symbol of our commitment to a better world. We renew that commitment every year, using ever more environmentally friendly materials up and down our supply chain.

Today, 100% of our retail packaging is cardboard made from 100% recycled paper and 100% water-based inks. This makes our packaging completely compostable and biodegradable. Within the next year, we will have phased out all plastic in our packaging, as well, making less waste and a more positive impact.

But there's more to sustainability than just packaging. We're also working to tackle waste and improve efficiency in other ways. We're reconfiguring our manufacturing processes, making them leaner and cleaner. We're installing the infrastructure necessary to achieve total carbon neutrality in our China HQ by 2024, and investing to make our factories and our entire supply chain carbon neutral by 2030.

However, we know that we can't do it alone; to create a greener future, we need the help of those who will inherit it. That's the impetus behind our Gym in a Box, a program that puts sustainably produced ZIVA workout gear into schools where young athletes can share in our commitment to their health and to the health of the great wide world. This commitment to sustainability is a natural extension of the ZIVA Way to Live.



A close-up photograph of a hand holding a black ZIVA 9 lb dumbbell. The dumbbell has a textured, hexagonal head with the number '9' and the brand name 'ZIVA' embossed on it. The background is a blurred gym environment with other dumbbells on a rack.

COMMERCIAL

Commercial quality materials and manufacturing with iconic, eye-catching design: that's been the soul of ZIVA® since the very beginning. The products in our Commercial Line are all built for the most demanding environments: gyms where clients come to be inspired, to train hard, to build better bodies, and better lives. We've made the products in this Line attractive, inspirational pieces that are rugged and durable, tough enough that gym-goers can grind out an excruciating set and drop their gear to the floor, while gym owners can feel proud watching them because they have the confidence that their equipment is made to last. From racks to rigs to bells, bumpers, bars, bags, and balls, every piece in the Commercial Line is designed to inspire, to lead users and owners to new heights of excellence and higher paths along The Way.



INFINITY

The INFINITY Series is the pinnacle of ZIVA®'s functional fitness, blending unparalleled versatility with a design ethos that redefines what fitness equipment can be. Each piece in the Series transforms a gym's space into a hub of beauty and innovation bursting with boundless functional training possibilities. These dynamic workout stations offer a modular approach to workouts and equipment storage, and invite users into a world where design meets function in the pursuit of fitness excellence. Used in conjunction with the INFINITY Series' many accessories, these pieces become infinite in the number of workouts they facilitate.







With INFINITY, users can go BEYOND.

INFINITY WALL MOUNTED MODULAR SYSTEM 121

The INFINITY Wall-Mounted Modular System 121 is a modular solution that turns fitness facility walls into centers for storage and training that can change on-the-fly for unparalleled functionality. Designed to utilize and beautify underused wall spaces, this piece offers the ability to anchor suspension trainers or resistance bands at a broad range of heights and angles, can serve as a body weight exercise or stretching station, or can provide a versatile storage solution capable of storing any and every form of functional fitness equipment. Its real promise, though, is in its ability to do all of that simultaneously, all with a sleek aesthetic is not just a statement of style but a testament to a gym's commitment to blending form with function.



| Order Code | Item Description |
|---------------|--|
| ZFS-XWMT-6715 | INFINITY Wall Mounted Modular System 121 |

| | |
|-----------------------|--|
| Description |  INFINITY Wall Mounted Modular System 121 |
| Specifications |  Expandable storage solution that maximizes floor space. It can be used as both a storage and training rack and can be infinitely expanded according to the need. Made of 3mm steel pipe and wooden boards. |
| Color Options |   Black powder-coated finish with grey detailing |
| Dimensions |  121cm x 30cm x 243cm - 86kg |
| Warranty |  Limited 10 year warranty on frames and welding; 1 year on plastic parts |



| Order Code | Item Description | Order Code | Item Description |
|---------------|--|---------------|--|
| ZFS-XWMT-6990 | INFINITY X Wall Mounted Modular System 121 x 2 | ZFS-XWMT-6992 | INFINITY Wall Mounted Modular System 121 x 4 |
| ZFS-XWMT-6991 | INFINITY X Wall Mounted Modular System 121 x 3 | ZFS-XWMT-6993 | INFINITY X Wall Mounted Modular System 121 x 5 |

INFINITY WALL MOUNTED MODULAR SYSTEM

The INFINITY Wall reimagines and reinvents the potential of fitness facility walls with its unparalleled modularity, functionality, and its premium design. Designed to utilize and beautify underused wall spaces, the INFINITY Wall is engineered for the elite. It offers the ability to anchor suspension trainers or resistance bands at a broad range of heights and angles, and can serve as a body weight exercise or stretching station, but it truly shines as a dynamic and versatile storage solution capable of storing any and every form of functional fitness equipment. Its sleek aesthetic is not just a statement of style but a testament to ZIVA®'s commitment to blending form with function, and is an essential centerpiece for any high-end gym or wellness facility seeking to offer their clients a unique and engaging fitness experience.

| | | |
|-----------------------|--|--|
| Description | | INFINITY Wall Mounted Modular System 121 |
| Specifications | | Expandable storage solution that maximizes floor space. It can be used as both a storage and training rack and can be infinitely expanded according to the need. Made of 3mm steel pipe and wooden boards. |
| Color Options | | Black powder-coated finish with grey detailing |
| Dimensions | | ZFS-XWMT-6715: 121cm x 30cm x 243cm - 86kg |
| Warranty | | Limited 10 year warranty on frames and welding; 1 year on plastic parts |



ZIVA
MULTIMEDIA SCREEN

ZIVA

ZIVA

ZIVA

ZIVA

ZIVA
MULTIMEDIA SCREEN

ZIVA

ZIVA

12 ZIVA 26
12 ZIVA 26

THE TERMINATOR

INFINITY BRIDGE

The INFINITY Bridge is the ultimate structure for multi-person suspension training. It offers anchor points at every conceivable angle and in every conceivable direction, and even in its shortest form is comfortably capable of supporting up to 10x suspension trainers at once. But it is far more than just a suspension training station. Compatible with every attachment in the INFINITY Series, the INFINITY Bridge serves as a gateway to the infinite possibilities of functional training, and does so with an aesthetic that makes for an unmistakably premium gym.



INFINITY BRIDGE 400

The INFINITY Bridge 400 delivers a full 4 meters of multi-person suspension training. It offers anchor points at every conceivable angle and in every conceivable direction, making it comfortably capable of supporting up to 10x suspension trainers at once. But like every INFINITY product, it is far more than just a suspension training station. Compatible with every attachment in the INFINITY Series, the INFINITY Bridge serves as a gateway to the infinite possibilities of functional training, and does so with an aesthetic that makes for an unmistakably premium gym. For medium-sized functional fitness and suspension training classes, the INFINITY Bridge 400 is a great choice.

INFINITY BRIDGE 525

The INFINITY Bridge 525 delivers a full 5.25 meters of multi-person suspension training. It offers anchor points at every conceivable angle and in every conceivable direction, making it comfortably capable of supporting up to 14x suspension trainers at once. But like every INFINITY product, it is far more than just a suspension training station. Compatible with every attachment in the INFINITY Series, the INFINITY Bridge serves as a gateway to the infinite possibilities of functional training, and does so with an aesthetic that makes for an unmistakably premium gym. For medium-large functional fitness and suspension training classes, the INFINITY Bridge 525 is a terrific choice.

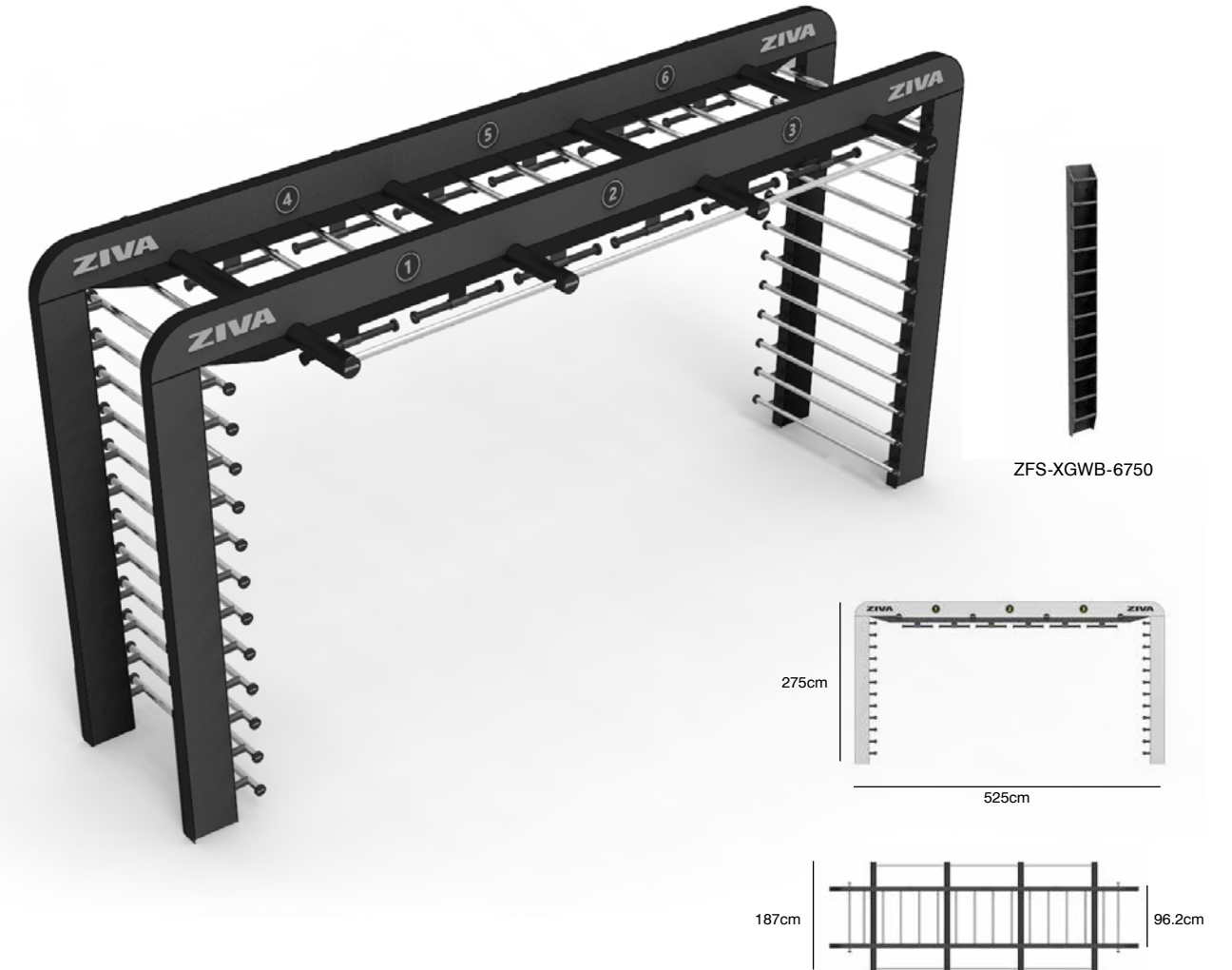
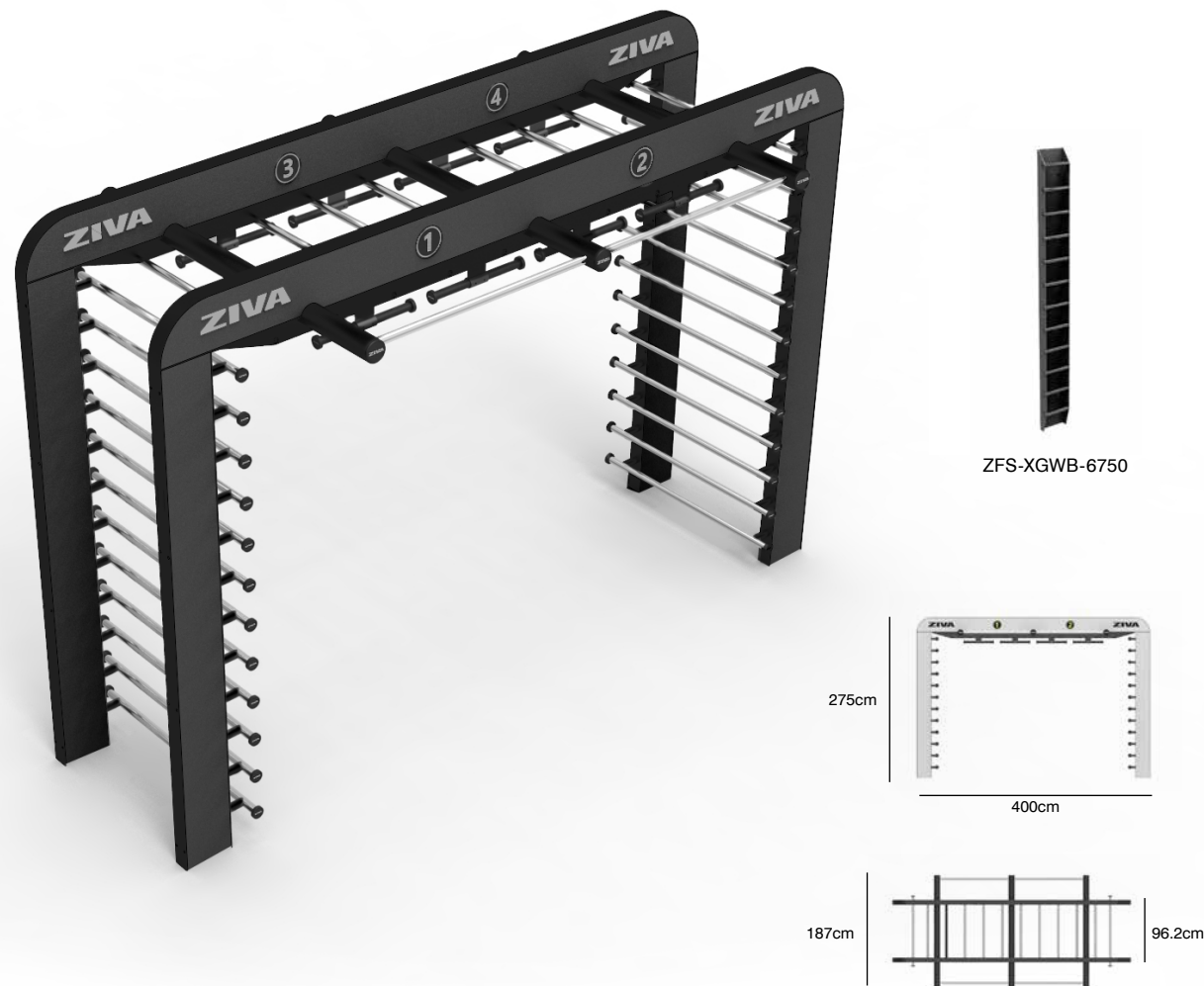

| Order Code | Item Description |
|---------------|----------------------------|
| ZFS-XBDG-6700 | INFINITY Bridge 400 |
| ZFS-XGWB-6750 | INFINITY Mini Gym Wall Bar |

| Order Code | Item Description |
|---------------|----------------------------|
| ZFS-XBDG-6701 | INFINITY Bridge 525 |
| ZFS-XGWB-6750 | INFINITY Mini Gym Wall Bar |

| | | |
|-----------------------|--|--|
| Description | | INFINITY Bridge 400 |
| Specifications | | Made with full commercial plate steel and fittings. Built to withstand the rigors of large member gyms, built to last and look amazing. Must be bolted to the floor. |
| Color Options | | Black powder-coated finish with grey detailing |
| Dimensions | | 400cm x 187cm x 275cm |
| Warranty | | Limited 10 year warranty on frames and welding; 1 year on plastic parts |

| | | |
|-----------------------|--|--|
| Description | | INFINITY Bridge 525 |
| Specifications | | Made with full commercial plate steel and fittings. Built to withstand the rigors of large member gyms, built to last and look amazing. Must be bolted to the floor. |
| Color Options | | Black powder-coated finish with grey detailing |
| Dimensions | | 525cm x 187cm x 275cm |
| Warranty | | Limited 10 year warranty on frames and welding; 1 year on plastic parts |

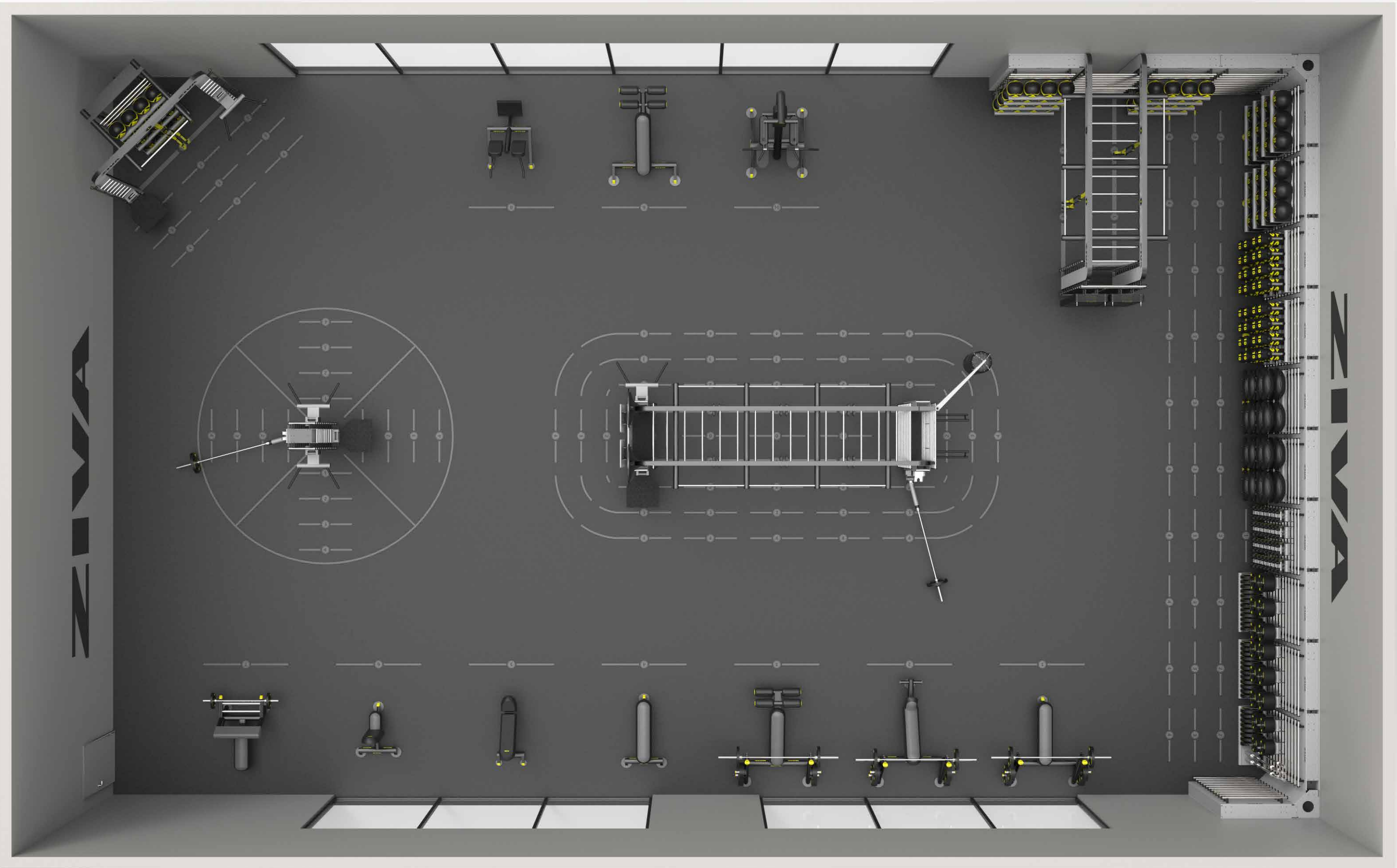

ZEL ZEP INFINITY TRAINING TOWER BRIDGE

The ZIVA® Infinity Training Tower Bridge, made from thick steel plate, 3mm steel tube rungs, and covered in a scratch-, corrosion-, and rust-resistant powder coat finish, is a customizable training hub. The rungs, located at every conceivable angle, fit any and all Infinity Training Accessories so it can be made to cater to any gym's unique clientele. The tough rungs also serve as anchors for suspension trainers, resistance bands, bodyweight work, and for stretching.

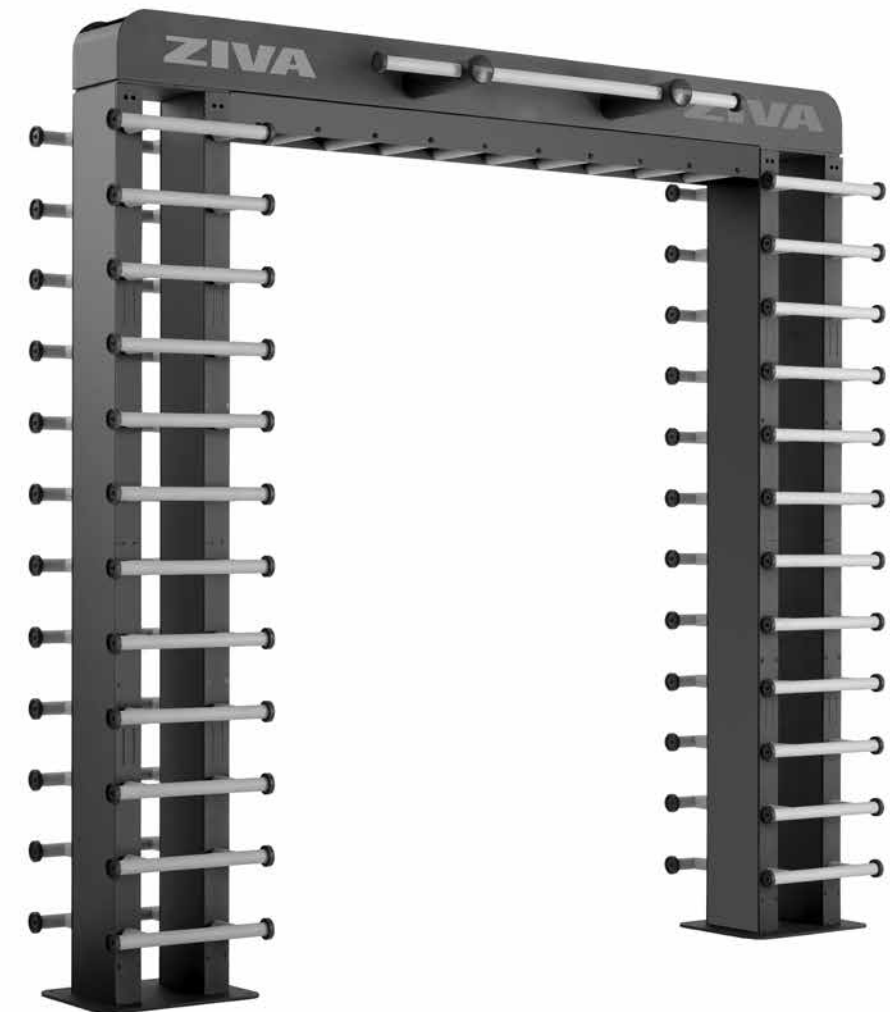

| | | | |
|------------------------------------|--|------------------------------------|--|
| Order Code ZFS-TBDG-7997 | Item Description INFINITY Training Tower Bridge 3m*2.43m | Order Code ZFS-TBDG-7998 | Item Description INFINITY Training Tower Bridge 3m*2.73m |
|------------------------------------|--|------------------------------------|--|

| | | |
|-----------------------|--|--|
| Description | | Infinity Training Tower Bridge |
| Specifications | | Made with full commercial plate steel and fittings. Built to withstand the rigors of large member gyms, built to last and look amazing. Must be bolted to the floor. |
| Product Color | | Black powder-coated finish with grey detailing |
| Dimensions | | ZFS-TBDG-7997: 387cm x 86cm x 243cm - 791kg ZFS-TBDG-7998: 387cm x 86cm x 273cm - 840kg |
| Warranty | | Limited 10 year warranty on frames and welding; 1 year on plastic parts |

ZIVA

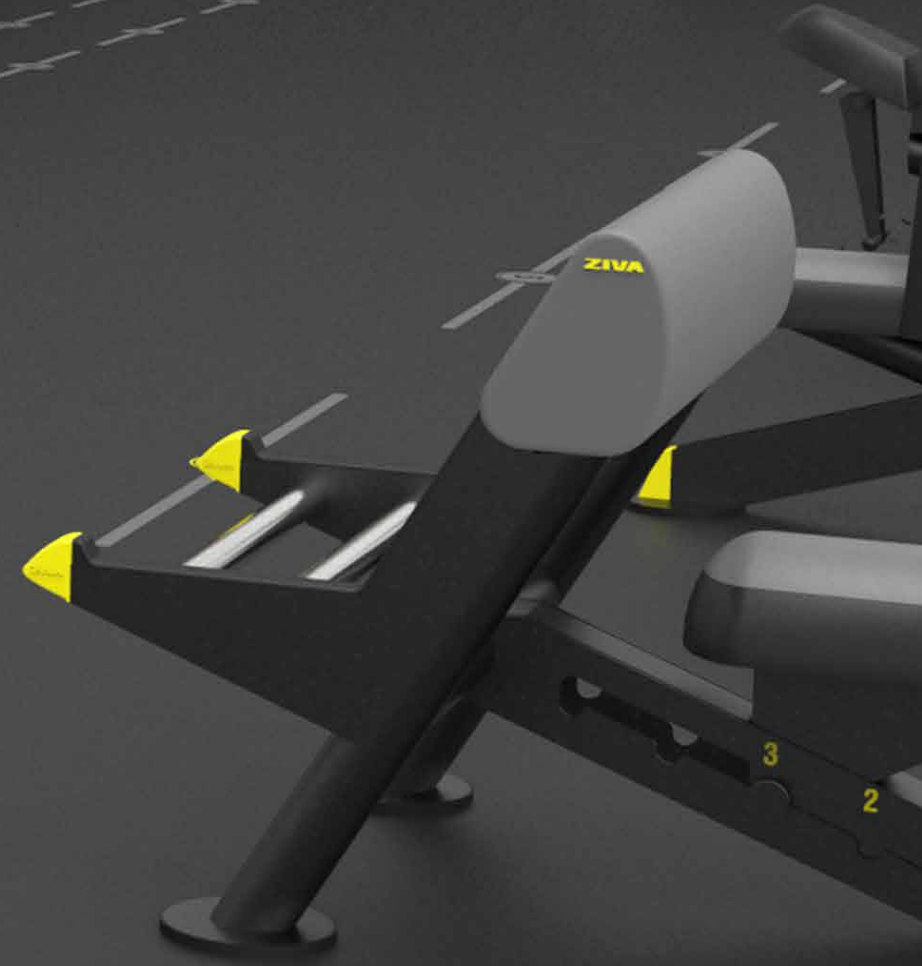
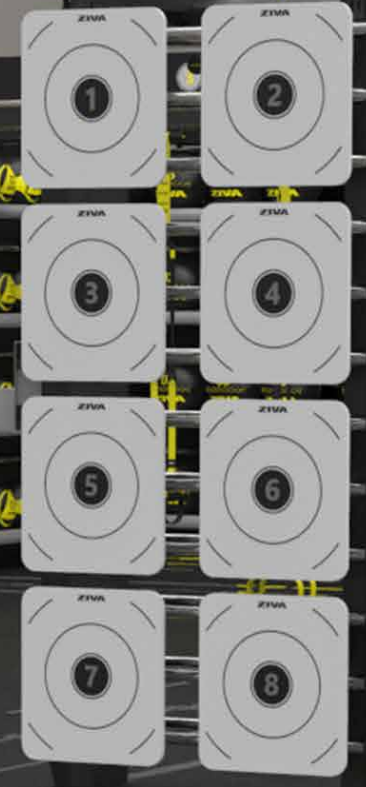

INFINITY WALL CORNER

The INFINITY Wall Corner totally transforms gyms' otherwise underutilized corner spaces into functional training hotspots, or - thanks to the incredible design of the INFINITY Series - whatever else a high-end facility might need it to be. This innovative structure offers anchor points for suspension training at an incredible array of angles, and it is compatible with all INFINITY Series attachments, so it can be used for storage as well as training. This piece, like all those in the INFINITY Series, is a blend of form and function and speaks to a facility's commitment to beautiful, inspiring workouts in beautiful, inspiring surroundings.





INFINITY WALL CORNER

The INFINITY Wall Corner delivers all the utility of the original INFINITY Corner in a package designed to fit more perfectly within and around the INFINITY Wall. This innovative structure offers anchor points for suspension training at an incredible array of angles, and is compatible with all INFINITY Series attachments. This piece, like all those in the INFINITY Series, is a blend of form and function and speaks to a facility's commitment to beautiful, inspiring workouts in beautiful, inspiring surroundings.



Order Code
ZFS-XCRN-5200

Item Description
INFINITY Wall Corner

| | | |
|-----------------------|--|--|
| Description | | INFINITY Wall Corner |
| Specifications | | Made with full commercial plate steel and fittings. Built to withstand the rigors of large member gyms, built to last and look amazing. Must be bolted to the floor. |
| Color Options | | Black powder-coated finish with grey detailing |
| Dimensions | | 231cm x 164cm x 255cm |
| Warranty | | Limited 10 year warranty on frames and welding; 1 year on plastic parts |

INFINITY TOWER

The INFINITY Tower stands as a beacon of innovation for functional fitness, a singular structure designed for ultimate versatility and engagement in functional training. The INFINITY Tower is not just equipment; it's a multi-faceted training platform. Its four-sided design allows for the creation of four distinct training stations, each tailored to a different aspect of functional fitness, from suspension training and resistance workouts to bodyweight exercises and mobility drills. Ideal for group sessions or fast-paced individual workouts, the Tower supports a seamless workout flow, making it a cornerstone for dynamic and efficient fitness programs. Designed for premium spaces, the Tower's sleek aesthetics serves as inspiration in the pursuit of a better body.



INFINITY TRAINING TOWER

On its own, the INFINITY Training Tower represents a near infinite variety of functional fitness workouts. It is not just equipment; it's a multi-faced training platform. Its four-sided design allows for the creation of four distinct training stations, each tailored to a different aspect of functional fitness, from suspension training and resistance workouts to body weight exercises and mobility drills, and can be used by more than 4x athletes at once, especially when including other equipment. All this make the INFINITY Training Tower ideal for group sessions or fast-paced individual workouts. It supports a seamless workout flow, making it a cornerstone for dynamic and efficient fitness programs. Designed for premium spaces, the Training Tower's sleek aesthetics serves as inspiration in the pursuit of a better body.

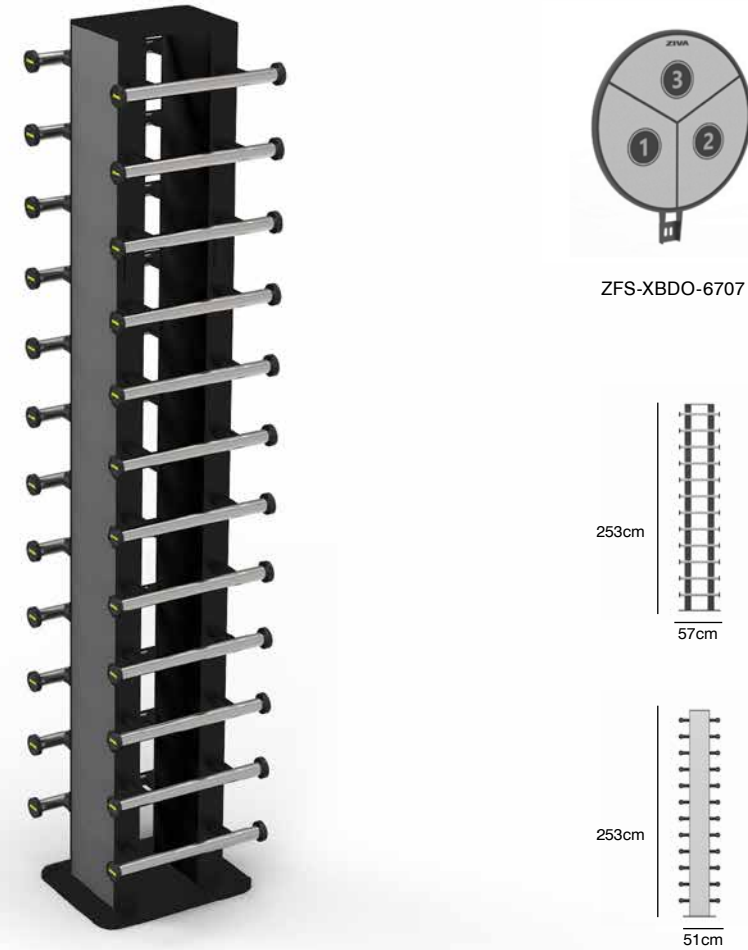

| Order Code | Item Description |
|---------------|-------------------------|
| ZFS-XTTR-6721 | INFINITY Training Tower |
| ZFS-XBDO-6707 | INFINITY Ball Target |

| | | |
|-----------------------|--|--|
| Description | | INFINITY Training Tower |
| Specifications | | Made with full commercial plate steel and fittings. Built to withstand the rigors of large member gyms, built to last and look amazing. Must be bolted to the floor. |
| Color Options | | Black powder-coated finish with grey detailing |
| Dimensions | | 57cm x 51cm x 253cm |
| Warranty | | Limited 10 year warranty on frames and welding; 1 year on plastic parts |

INFINITY TRAINING TOWER WITH 4 BOXING BAG SUPPORT

The INFINITY Training Tower with 4 Boxing Bag Supports is the ultimate expression of this equipment's capacity to deliver unforgettable and irresistible workouts to groups of athletes. Its four-sided, four-poled design allows 4x trainees to converge and box at one time in a single session of intense cardio, while the INFINITY Series' unique design allows for the creation of four distinct training stations, each tailored to a different aspect of functional fitness. It's compact yet fully loaded design supports a seamless workout flow, making it a cornerstone for dynamic and efficient fitness programs. Designed for premium spaces with a boxing bent, the Training Tower with 4 Boxing Bag Support brings sleek, inspiring aesthetics for those in the pursuit of a better boxing body.



| Order Code | Item Description |
|---------------|---|
| ZFS-XTTR-6776 | INFINITY Training Tower with 4 Boxing Bag Support |
| ZFS-XBDO-6708 | INFINITY Boxing Bag Support |

| | | |
|-----------------------|--|--|
| Description | | INFINITY Training Tower with 4 Boxing Bag Support |
| Specifications | | Made with full commercial plate steel and fittings. Built to withstand the rigors of large member gyms, built to last and look amazing. Must be bolted to the floor. |
| Color Options | | Black powder-coated finish with grey detailing |
| Dimensions | | 57cm x 51cm x 253cm |
| Warranty | | Limited 10 year warranty on frames and welding; 1 year on plastic parts |

INFINITY REMOVABLE ACCESSORIES

The ZIVA® INFINITY Series is built on principles of superior design and functional fitness, and at its core is an unmatched modularity powered by its Accessories. The INFINITY Removable Accessories allow gym owners, trainers, and users to create functional fitness equipment that is built to purpose for a given workout, giving them the ability to make an infinite number of functional fitness workouts. Whatever their goals, whatever their preferences, any time they want, these quickly Removable Accessories allow them to craft the perfect workout with the most inspiring equipment and the most inspiring aesthetics.



| Order Code | Item Description | Order Code | Item Description |
|---------------|--------------------------------|---------------|---|
| ZFS-XACS-6735 | INFINITY Fixed Parallels | ZFS-XACS-6743 | INFINITY Olympic Bumper And Bar Storage |
| ZFS-XACS-6736 | INFINITY Adjustable Parallels | ZFS-XACS-6744 | INFINITY Olympic Bumper Storage |
| ZFS-XACS-6737 | INFINITY Plyometric Board | ZFS-XACS-6745 | INFINITY Dumbbell Storage |
| ZFS-XACS-6738 | INFINITY Wall Ball Target | ZFS-XACS-6746 | INFINITY Bag Storage |
| ZFS-XACS-6739 | INFINITY Torso Trainer | ZFS-XACS-6748 | INFINITY Mat Storage |
| ZFS-XACS-6740 | INFINITY Universal Bar Storage | ZFS-XACS-6749 | INFINITY Universal Box |
| ZFS-XACS-6741 | INFINITY Universal Shelf | ZFS-XACS-6773 | INFINITY TV Attachment |
| ZFS-XACS-6742 | INFINITY Olympic Disc Storage | | |





| | | |
|----------------------|--|--------------------------------|
| Description | | INFINITY Removable Accessories |
| Color Options | | Grey |
| Warranty | | Limited 6 year warranty |

INFINITY RUBBER MAT

The ZIVA® INFINITY Series includes a range of premium rubber flooring options that have been developed and designed to offer the best performance and the most premium aesthetics to the most demanding athletes in the most inspiring facilities. This non-slip, high density flooring provides superior shock absorption, decreasing impact on athletes' joints and on floors when weights are dropped, making this flooring perfect for all manner of intense functional fitness use. The INFINITY Rubber Mat is available in a range of colors, textures, and thicknesses, so high-end gyms can tailor its looks to their desired interior design. Whatever look is chosen, like every piece in the INFINITY Series, this Mat elevates its surroundings with an unmistakably premium feel.



| Order Code | Item Description | Order Code | Item Description |
|---------------|--------------------------------------|---------------|--|
| ZFS-XRBM-6725 | INFINITY Rubber Mat Bridge 400 - 8mm | ZFS-XRBM-6729 | INFINITY Rubber Mat Corner - 8mm |
| ZFS-XRBM-6726 | INFINITY Rubber Mat Bridge 525 - 8mm | ZFS-XRBM-6730 | INFINITY Rubber Mat Training Tower - 8mm |

| | | |
|-----------------------|---|---|
| Description |  | INFINITY Rubber Mat |
| Specifications |  | Designed for heavy equipment, indoor cycling, free-weights and functional training. Shock absorption and non-slip floor for functional training areas, and also for heavy equipment and free weights. ZFS-XRBM-6725 (63 pcs) ZFS-XRBM-6726 (84 pcs) ZFS-XRBM-6729 (25 pcs) ZFS-XRBM-6730 (36 pcs) |
| Dimensions |  | 8mm thickness with interlocking puzzle tiles that are 1m x 1m |
| Color Options |  |  Black / Grey |



FREE WEIGHTS

The timeless training tools that have inspired fitness revolutions throughout the ages and throughout the world. Dumbbells, barbells, weight discs, and more form the foundation of strength and hypertrophy training.



A close-up, low-angle shot of a muscular man's torso and arms as he performs a bicep curl. He is holding a black ZIVA dumbbell with both hands. The dumbbell has the ZIVA logo on the weight plates. The man's skin is glistening with sweat, and his muscles are highly defined. The background is blurred, showing a gym setting with other dumbbells on the floor.

At ZIVA, free weights are our bread and butter. For over a decade, we have designed, manufactured, and delivered free weights to fitness facilities of every size and description all over the world. Over the years, we have earned a reputation for commercial quality, precision-calibrated free weights that stand up to the most intense, high-traffic environments. Our free weight products now include various sizes, shapes, and materials to offer something for every aesthetic and budget.

The ZVO Series delivers the pinnacle of performance and quality with second-to-none design and construction made especially for gyms seeking the best of the best.

The SL Series brings an attractive mid-range selection of products that have both style and terrific performance.

And the XP Series offers no-nonsense, always great commercial quality on dumbbells and barbells that make a fantastic foundation to any gym's free weight section.



“

ZIVA is Basic Fit's preferred free weights and functional training products partner in Europe. ZIVA delivers premium quality products and customized solutions for Basic Fit and our members and supports our growth in Europe.

Rene Moos

CEO

”

BASIC-FIT

DUMBBELLS

PREMIUM



Use: Free weight areas for heavy training and super high usage

Material: Urethane

The Bottom Line: For those who demand the best

Customer: Big club chains, premium gyms, and top hotels

Warranty: 5 years

MID-RANGE



Use: Free weight areas for heavy training and heavy use

Material: Urethane

The Bottom Line: A no-nonsense foundation to any terrific free weight zone

Customer: Club chains, mid-market gyms and studios

Warranty: 4 years SL urethane dumbbells, 3 years SL urethane hexagons, 3 years XP

ENTRY



PERFORMANCE

Use: Free weight areas for lighter use and training

Material: RPU

The Bottom Line: Good quality at a great price

Customer: Small budget gyms and boutique studios

Warranty: 2 years

ZVO SOLID STEEL URETHANE DUMBBELLS

5 YEAR WARRANTY



Solid steel head design with interlocking head to handle

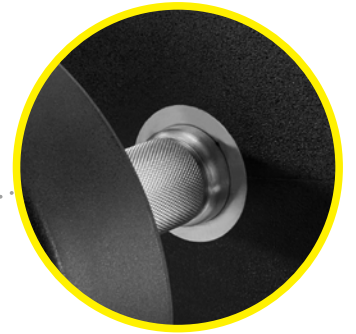

Premium hard chrome straight handle with stainless steel ring at joint



Large coloured numbers for easy weight size ID



Tested and compliant to RoHS



Premium hard wearing PU (Polyurethane)



5 year warranty









ZVO SOLID STEEL URETHANE DUMBBELLS

ZIVA® ZVO Solid Steel Urethane Dumbbells use our classic, iconic dumbbell design and are made as a single, ultra-durable piece of solid steel. Long-lasting urethane-coated heads deliver unparalleled durability; are UV-, corrosion-, and tear-resistant; and provide superior color accuracy when reproducing custom logos. Scratch-proof chrome-finished handles with grip-assisting hill knurling round out this elite design, serving up a package that is an immediate indicator of a facility's continual commitment to the highest quality.



| Order Code | Item Description | Order Code | Item Description |
|---------------|--|---------------|--|
| ZVO-DBPU-1637 | ZVO Solid Steel Urethane Dumbbell 2kg | ZVO-DBPU-1652 | ZVO Solid Steel Urethane Dumbbell 32kg |
| ZVO-DBPU-1638 | ZVO Solid Steel Urethane Dumbbell 4kg | ZVO-DBPU-1653 | ZVO Solid Steel Urethane Dumbbell 34kg |
| ZVO-DBPU-1639 | ZVO Solid Steel Urethane Dumbbell 6kg | ZVO-DBPU-1654 | ZVO Solid Steel Urethane Dumbbell 36kg |
| ZVO-DBPU-1640 | ZVO Solid Steel Urethane Dumbbell 8kg | ZVO-DBPU-1655 | ZVO Solid Steel Urethane Dumbbell 38kg |
| ZVO-DBPU-1641 | ZVO Solid Steel Urethane Dumbbell 10kg | ZVO-DBPU-1656 | ZVO Solid Steel Urethane Dumbbell 40kg |
| ZVO-DBPU-1642 | ZVO Solid Steel Urethane Dumbbell 12kg | ZVO-DBPU-1657 | ZVO Solid Steel Urethane Dumbbell 42kg |
| ZVO-DBPU-1643 | ZVO Solid Steel Urethane Dumbbell 14kg | ZVO-DBPU-1658 | ZVO Solid Steel Urethane Dumbbell 44kg |
| ZVO-DBPU-1644 | ZVO Solid Steel Urethane Dumbbell 16kg | ZVO-DBPU-1659 | ZVO Solid Steel Urethane Dumbbell 46kg |
| ZVO-DBPU-1645 | ZVO Solid Steel Urethane Dumbbell 18kg | ZVO-DBPU-1660 | ZVO Solid Steel Urethane Dumbbell 48kg |
| ZVO-DBPU-1646 | ZVO Solid Steel Urethane Dumbbell 20kg | ZVO-DBPU-1661 | ZVO Solid Steel Urethane Dumbbell 50kg |
| ZVO-DBPU-1647 | ZVO Solid Steel Urethane Dumbbell 22kg | ZVO-DBPU-1662 | ZVO Solid Steel Urethane Dumbbell 52kg |
| ZVO-DBPU-1648 | ZVO Solid Steel Urethane Dumbbell 24kg | ZVO-DBPU-1663 | ZVO Solid Steel Urethane Dumbbell 54kg |
| ZVO-DBPU-1649 | ZVO Solid Steel Urethane Dumbbell 26kg | ZVO-DBPU-1664 | ZVO Solid Steel Urethane Dumbbell 56kg |
| ZVO-DBPU-1650 | ZVO Solid Steel Urethane Dumbbell 28kg | ZVO-DBPU-1665 | ZVO Solid Steel Urethane Dumbbell 58kg |
| ZVO-DBPU-1651 | ZVO Solid Steel Urethane Dumbbell 30kg | ZVO-DBPU-1666 | ZVO Solid Steel Urethane Dumbbell 60kg |

| | | |
|----------------------|---|--|
| Description |  | ZVO Solid Steel Urethane Dumbbell |
| Coating |  | Ultra-premium, hard-wearing urethane coating |
| Handle |  | Premium hard chrome handle with stainless steel ring at joint |
| Increments |  | 2kg increments from 2kg - 60kg |
| Color Options |  |  Black / Grey / White |
| Warranty |  | Limited 5 year warranty |

ZVO SOLID STEEL URETHANE BARBELL

ZIVA® ZVO Solid Steel Urethane Barbells take the age-old straight barbell design and crafts them with elite premium quality materials. Each barbell is cast from a single piece of solid steel, providing unsurpassed durability that is made even better by the use of a urethane-coat that features tear, UV, and water resistance. The bars themselves feature a scratch-resistant hard chrome finish and grip-assisting knurling on the sides with a knurl-free center. When set alongside ZVO Solid Steel Urethane Dumbbells, gyms gain a unified, elite look as well as a complete free weight package that is sure to make members proud.



| Order Code | Item Description | Order Code | Item Description |
|---------------|---|---------------|---------------------------------------|
| ZVO-BSPU-1690 | ZVO Solid Steel Urethane Barbell 10kg | ZVO-BSPU-1695 | ZVO Solid Steel Urethane Barbell 25kg |
| ZVO-BSPU-1691 | ZVO Solid Steel Urethane Barbell 12.5kg | ZVO-BSPU-1696 | ZVO Solid Steel Urethane Barbell 30kg |
| ZVO-BSPU-1692 | ZVO Solid Steel Urethane Barbell 15kg | ZVO-BSPU-1697 | ZVO Solid Steel Urethane Barbell 35kg |
| ZVO-BSPU-1693 | ZVO Solid Steel Urethane Barbell 17.5kg | ZVO-BSPU-1698 | ZVO Solid Steel Urethane Barbell 40kg |
| ZVO-BSPU-1694 | ZVO Solid Steel Urethane Barbell 20kg | ZVO-BSPU-1699 | ZVO Solid Steel Urethane Barbell 45kg |

| | | |
|----------------------|--|---|
| Description | | ZVO Solid Steel Urethane Barbell |
| Coating | | Ultra-premium, hard-wearing urethane coating |
| Handle | | Premium hard chrome handle with stainless steel ring at joint |
| Increments | | 2.5kg increments from 10kg - 20kg and 5kg increments from 20kg - 45kg |
| Color Options | | Black / Grey / White |
| Warranty | | Limited 5 year warranty |

ZVO SOLID STEEL URETHANE EZ CURL BARBELL

ZIVA® ZVO Solid Steel Urethane EZ Curl Barbells take the age-old EZ barbell design and crafts them with elite premium quality materials. Each barbell is cast from a single piece of solid steel, providing unsurpassed durability that is made even better by the use of a urethane-coat that features tear, UV, and water resistance. The bars themselves feature a scratch-resistant hard chrome finish and grip-assisting knurling on the sides with a knurl-free center. When set alongside ZVO Solid Steel Urethane Dumbbells, gyms gain a unified, elite look as well as a complete free weight package that is sure to make members proud.



| Order Code | Item Description | Order Code | Item Description |
|---------------|---|---------------|---|
| ZVO-BCPU-1602 | ZVO Solid Steel Urethane EZ Curl Barbell 10kg | ZVO-BCPU-1607 | ZVO Solid Steel Urethane EZ Curl Barbell 25kg |
| ZVO-BCPU-1603 | ZVO Solid Steel Urethane EZ Curl Barbell 12.5kg | ZVO-BCPU-1608 | ZVO Solid Steel Urethane EZ Curl Barbell 30kg |
| ZVO-BCPU-1604 | ZVO Solid Steel Urethane EZ Curl Barbell 15kg | ZVO-BCPU-1609 | ZVO Solid Steel Urethane EZ Curl Barbell 35kg |
| ZVO-BCPU-1605 | ZVO Solid Steel Urethane EZ Curl Barbell 17.5kg | ZVO-BCPU-1610 | ZVO Solid Steel Urethane EZ Curl Barbell 40kg |
| ZVO-BCPU-1606 | ZVO Solid Steel Urethane EZ Curl Barbell 20kg | ZVO-BCPU-1611 | ZVO Solid Steel Urethane EZ Curl Barbell 45kg |

| | | |
|----------------------|--|---|
| Description | | ZVO Solid Steel Urethane EZ Curl Barbell |
| Coating | | Ultra-premium, hard-wearing urethane coating |
| Handle | | Premium hard chrome handle with stainless steel ring at joint |
| Increments | | 2.5kg increments from 10kg - 20kg and 5kg increments from 20kg - 45kg |
| Color Options | | Black / Grey / White |
| Warranty | | Limited 5 year warranty |



ZVO SOLID STEEL URETHANE STUDIO DUMBBELLS (1-10KG)

ZIVA® ZVO Solid Steel Urethane Studio Dumbbells, made especially for intense studio sessions and HIIT workouts, use classic round-head dumbbell design and are cast from a single piece of solid steel for unsurpassed durability and performance. This durability is further enhanced with a long-lasting urethane-coating that delivers superior color accuracy for custom logos, along with UV-, water, and tear resistance. Scratch-proof chrome-finished handles with grip-assisting knurling round out the design for these premium elite dumbbells, serving up a package that is an immediate indicator of a facility's continual commitment to the highest quality.



Order Code ZVO-DBPU-1584
Item Description ZVO Solid Steel Urethane Studio Dumbbell Set 1-10kg (10 pairs), 110kg

| | | |
|----------------------|--|---|
| Description | | ZVO Solid Steel Urethane Dumbbell |
| Coating | | Ultra-premium, hard-wearing urethane coating |
| Handle | | Premium hard chrome handle with stainless steel ring at joint |
| Increments | | 1kg increments from 1kg - 10kg |
| Color Options | | Black / Grey / White |
| Warranty | | Limited 5 year warranty |



ZVO URETHANE FUNCTIONAL TRIBELL

The innovative and iconic ZIVA® tribell design offers a sleek look while keeping the bells from rolling away. With an ultra-durable, scratch-, tear-, and scuff-resistant urethane coating, the ZVO Urethane Functional Tribell is a best-in-class piece that's both compact and stable, sticking in sweaty hands thanks to grippy urethane knurling, making them the perfect solution for light resistance group classes that serve as a major draw for many gyms.



| Order Code | Item Description | Order Code | Item Description |
|---------------|--|---------------|--------------------------------------|
| ZVO-PUTF-3070 | ZVO Urethane Functional Tribell 1kg | ZVO-PUTF-3075 | ZVO Urethane Functional Tribell 6kg |
| ZVO-PUTF-3071 | ZVO Urethane Functional Tribell 2kg | ZVO-PUTF-3076 | ZVO Urethane Functional Tribell 7kg |
| ZVO-PUTF-3072 | ZVO Urethane Functional Tribell 3kg | ZVO-PUTF-3078 | ZVO Urethane Functional Tribell 8kg |
| ZVO-PUTF-3073 | ZVO Urethane Functional Tribell 4kg | ZVO-PUTF-3079 | ZVO Urethane Functional Tribell 9kg |
| ZVO-PUTF-3074 | ZVO Urethane Functional Tribell 5kg | ZVO-PUTF-3080 | ZVO Urethane Functional Tribell 10kg |
| ZVO-PUTF-3081 | ZVO Urethane Functional Tribell 1kg - 10kg Set | | |

| | | |
|----------------------|--|---------------------------------------|
| Description | | ZVO Urethane Functional Tribell |
| Coating | | Premium hard-wearing urethane coating |
| Increments | | 1kg increments |
| Color Options | | Black / Grey / White |
| Warranty | | Limited 3 year warranty |

ZVO URETHANE GRIP DISCS

The ZIVA® ZVO Urethane Grip Disc, made to fit any standard Olympic Bar, is a precision cast premium elite disc that features sleek, eye-catching design for its handles and face, easy ID numbering, beveled edges and three handles for easy pick up from any angle, and an ultra-long-lasting UV-, water-, and tear-resistant urethane coating that stays looking newer for longer. This urethane coat also has the added benefit of giving a bit of bounce, protecting not only the steel plate underneath but the surrounding environment, as well, so a dropped weight disc doesn't necessarily mean a dented floor.



| Order Code | Item Description | Order Code | Item Description |
|---------------|-------------------------------|------------------|-----------------------------|
| ZVO-DCPU-1618 | ZVO Urethane Grip Disc 1.25kg | ZVO-DCPU-1615-GY | ZVO Urethane Grip Disc 15kg |
| ZVO-DCPU-1612 | ZVO Urethane Grip Disc 2.5kg | ZVO-DCPU-1616-GY | ZVO Urethane Grip Disc 20kg |
| ZVO-DCPU-1613 | ZVO Urethane Grip Disc 5kg | ZVO-DCPU-1617-GY | ZVO Urethane Grip Disc 25kg |
| ZVO-DCPU-1614 | ZVO Urethane Grip Disc 10kg | | |

| | | |
|----------------------|--|---|
| Description | | ZVO Urethane Grip Disc |
| Coating | | Ultra-premium urethane surface coating |
| Color Options | | Black / Grey / White |
| Increments | | 1.25kg, 2.5kg with 5kg increments from 5kg - 25kg |
| Warranty | | Limited 5 year warranty |

SL URETHANE DUMBBELLS

4 YEAR WARRANTY



Solid steel head design with interlocking head to handle

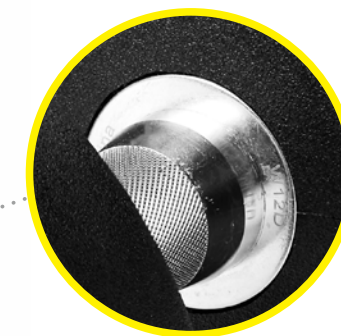

Premium hard chrome handle with stainless steel ring at joint



Large coloured numbers for easy weight size ID



Tested and compliant to RoHS



Premium Urethane coating









4 year warranty

SL URETHANE DUMBBELLS (2KG INCREMENTS)

The ZIVA® SL Urethane Dumbbells use a classic dumbbell design similar to the ZVO, with long-lasting UV-, water, and tear-resistant urethane-coated heads, but offer an alternative look and more muted range of highly durable color choices. Combined with hard chrome-finished handles and grip-assisting knurling, these dumbbells deliver a unique aesthetic that features iconic ZIVA design language and an undeniably premium feel. Available in 2kg increments from 2-60kg, a complete set forms a gym's firm foundation.



| Order Code | Item Description | Order Code | Item Description |
|---------------|---------------------------|---------------|---------------------------|
| ZSL-PUDB-9115 | SL Urethane Dumbbell 2kg | ZSL-PUDB-9130 | SL Urethane Dumbbell 32kg |
| ZSL-PUDB-9116 | SL Urethane Dumbbell 4kg | ZSL-PUDB-9131 | SL Urethane Dumbbell 34kg |
| ZSL-PUDB-9117 | SL Urethane Dumbbell 6kg | ZSL-PUDB-9132 | SL Urethane Dumbbell 36kg |
| ZSL-PUDB-9118 | SL Urethane Dumbbell 8kg | ZSL-PUDB-9133 | SL Urethane Dumbbell 38kg |
| ZSL-PUDB-7357 | SL Urethane Dumbbell 10kg | ZSL-PUDB-7369 | SL Urethane Dumbbell 40kg |
| ZSL-PUDB-9120 | SL Urethane Dumbbell 12kg | ZSL-PUDB-9135 | SL Urethane Dumbbell 42kg |
| ZSL-PUDB-9121 | SL Urethane Dumbbell 14kg | ZSL-PUDB-9136 | SL Urethane Dumbbell 44kg |
| ZSL-PUDB-9122 | SL Urethane Dumbbell 16kg | ZSL-PUDB-9137 | SL Urethane Dumbbell 46kg |
| ZSL-PUDB-9123 | SL Urethane Dumbbell 18kg | ZSL-PUDB-9138 | SL Urethane Dumbbell 48kg |
| ZSL-PUDB-7361 | SL Urethane Dumbbell 20kg | ZSL-PUDB-7373 | SL Urethane Dumbbell 50kg |
| ZSL-PUDB-9125 | SL Urethane Dumbbell 22kg | ZSL-PUDB-7376 | SL Urethane Dumbbell 52kg |
| ZSL-PUDB-9126 | SL Urethane Dumbbell 24kg | ZSL-PUDB-7377 | SL Urethane Dumbbell 54kg |
| ZSL-PUDB-9127 | SL Urethane Dumbbell 26kg | ZSL-PUDB-7378 | SL Urethane Dumbbell 56kg |
| ZSL-PUDB-9128 | SL Urethane Dumbbell 28kg | ZSL-PUDB-7379 | SL Urethane Dumbbell 58kg |
| ZSL-PUDB-7365 | SL Urethane Dumbbell 30kg | ZSL-PUDB-7644 | SL Urethane Dumbbell 60kg |

| | | |
|----------------------|---|--|
| Description |  | SL Urethane Dumbbell |
| Coating |  | Premium hard-wearing urethane coating |
| Handle |  | Premium hard chrome handle |
| Increments |  | 2kg increments |
| Color Options |  |  Black / Yellow |
| Warranty |  | Limited 4 year warranty |









SL URETHANE BARBELLS

The ZIVA® SL Urethane Barbell feature a different design than their ZVO counterparts but speak the same unmistakable ZIVA design language, and offer a more muted color range with the same long-lasting, hard-wearing urethane-coated heads and chip-resistant hard chrome finish with grip-assisting knurling. The SL Urethane Barbell brings an undeniably premium look and feel to the free weight section.



| Order Code | Item Description | Order Code | Item Description |
|---------------|----------------------------|---------------|--------------------------|
| ZSL-PUBB-8374 | SL Urethane Barbell 10kg | ZSL-PUBB-8379 | SL Urethane Barbell 25kg |
| ZSL-PUBB-8375 | SL Urethane Barbell 12.5kg | ZSL-PUBB-8380 | SL Urethane Barbell 30kg |
| ZSL-PUBB-8376 | SL Urethane Barbell 15kg | ZSL-PUBB-8381 | SL Urethane Barbell 35kg |
| ZSL-PUBB-8377 | SL Urethane Barbell 17.5kg | ZSL-PUBB-8382 | SL Urethane Barbell 40kg |
| ZSL-PUBB-8378 | SL Urethane Barbell 20kg | ZSL-PUBB-8383 | SL Urethane Barbell 45kg |







| | | |
|----------------------|---|--|
| Description |  | SL Urethane Barbell |
| Coating |  | Premium hard-wearing urethane coating |
| Handle |  | Premium hard chrome handle |
| Increments |  | 2.5kg increments from 10kg - 20kg and 5kg increments from 20kg - 45kg |
| Color Options |  |  Black / Yellow |
| Warranty |  | Limited 4 year warranty |

SL URETHANE EZ CURL BARBELLS

The ZIVA® SL Urethane EZ Curl Barbell feature a different design than their ZVO counterparts but speak the same unmistakable ZIVA design language, and offer a more muted color range with the same long-lasting, hard-wearing urethane-coated heads and chip-resistant hard chrome finish with grip-assisting knurling. The SL Urethane EZ Curl Barbell set brings an undeniably premium look and feel to the free weight section.



| Order Code | Item Description | Order Code | Item Description |
|---------------|------------------------------------|---------------|----------------------------------|
| ZSL-PUEZ-9374 | SL Urethane EZ Curl Barbell 10kg | ZSL-PUEZ-9379 | SL Urethane EZ Curl Barbell 25kg |
| ZSL-PUEZ-9375 | SL Urethane EZ Curl Barbell 12.5kg | ZSL-PUEZ-9380 | SL Urethane EZ Curl Barbell 30kg |
| ZSL-PUEZ-9376 | SL Urethane EZ Curl Barbell 15kg | ZSL-PUEZ-9381 | SL Urethane EZ Curl Barbell 35kg |
| ZSL-PUEZ-9377 | SL Urethane EZ Curl Barbell 17.5kg | ZSL-PUEZ-9382 | SL Urethane EZ Curl Barbell 40kg |
| ZSL-PUEZ-9378 | SL Urethane EZ Curl Barbell 20kg | ZSL-PUEZ-9383 | SL Urethane EZ Curl Barbell 45kg |

| | | |
|----------------------|---|--|
| Description |  | SL Urethane EZ Curl Barbell |
| Coating |  | Premium hard-wearing urethane coating |
| Handle |  | Premium hard chrome handle |
| Increments |  | 2.5kg increments from 10kg - 20kg and 5kg increments from 20kg - 45kg |
| Color Options |  |  Black / Yellow |
| Warranty |  | Limited 4 year warranty |

SL URETHANE HEXAGON DUMBBELLS

3 YEAR WARRANTY

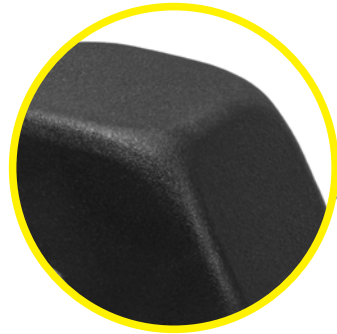

Premium polyurethane coating



Large coloured numbers for easy weight size ID

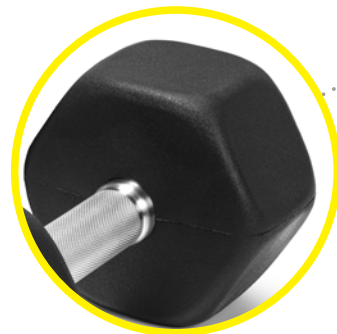

Steel cores



Patented design



Tested and compliant to RoHS

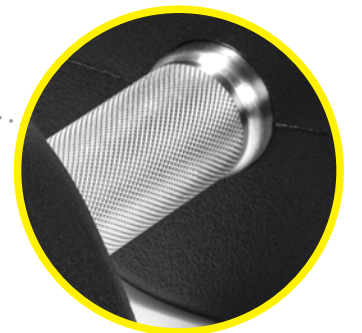

Hard chrome handle



3 year warranty

SL URETHANE HEXAGON DUMBBELLS (1-10KG)

The ZIVA® SL Urethane Hexagon Dumbbell updates the old classic with a coat of unparalleled durability. Available in 1kg increments in the 1-10kg range, these dumbbells are perfect for fast paced HIIT training and warm-ups. They feature the always iconic no-roll design; straight, fully knurled chrome-finished handles; and large, easy ID weight numbers. Their urethane coat is where they are strongest. This ultra-long-lasting material is scratch- and scuff-proof and gives these dumbbells a wonderfully long lifespan with an undeniably premium look and feel.



| Order Code | Item Description | Order Code | Item Description |
|--------------------|---|--------------------|--|
| ZSL-DBUX-JA53-GYWT | SL Hexagon Urethane Studio Dumbbell 1kg | ZSL-DBUX-JA58-GYWT | SL Hexagon Urethane Studio Dumbbell 6kg |
| ZSL-DBUX-JA54-GYWT | SL Hexagon Urethane Studio Dumbbell 2kg | ZSL-DBUX-JA59-GYWT | SL Hexagon Urethane Studio Dumbbell 7kg |
| ZSL-DBUX-JA55-GYWT | SL Hexagon Urethane Studio Dumbbell 3kg | ZSL-DBUX-JA60-GYWT | SL Hexagon Urethane Studio Dumbbell 8kg |
| ZSL-DBUX-JA56-GYWT | SL Hexagon Urethane Studio Dumbbell 4kg | ZSL-DBUX-JA61-GYWT | SL Hexagon Urethane Studio Dumbbell 9kg |
| ZSL-DBUX-JA57-GYWT | SL Hexagon Urethane Studio Dumbbell 5kg | ZSL-DBUX-JA62-GYWT | SL Hexagon Urethane Studio Dumbbell 10kg |
| ZSL-DBUX-JA52-GYWT | SL Hexagon Urethane Studio Dumbbell Set 1-10kg (10 Pairs) | | |

| | | |
|-----------------------|--|---|
| Description | | SL Hexagon Urethane Dumbbells |
| Specifications | | Premium polyurethane surface coating. <i>The SL Hexagon Urethane Dumbbell can only be stored on the ZST-DBST-4967 rack and select Studio Hexagon racks.</i> |
| Handle | | Hard chromed handle (125mm) |
| Color Options | | Black / Grey / White |
| Increments | | 1kg increments |
| Warranty | | Limited 3 year warranty |



SL URETHANE HEXAGON DUMBBELLS (2KG INCREMENTS)

The ZIVA® SL Urethane Hexagon Dumbbell updates the old classic with a coat of unparalleled durability. Offered in 2kg increments up to 50kg, these dumbbells are made for heavy-duty training. They feature the iconic and necessary no-roll design; straight, fully knurled chrome-finished handles; and large, easy ID weight numbers. Their urethane coat is where they are strongest. This ultra-long-lasting material is scratch- and scuff-proof and gives these dumbbells a wonderfully long lifespan with an undeniably premium look and feel.



| Order Code | Item Description | Order Code | Item Description |
|---------------|-----------------------------------|---------------|-----------------------------------|
| ZSL-DBUX-JA64 | SL Hexagon Urethane Dumbbell 2kg | ZSL-DBUX-JA77 | SL Hexagon Urethane Dumbbell 28kg |
| ZSL-DBUX-JA65 | SL Hexagon Urethane Dumbbell 4kg | ZSL-DBUX-JA78 | SL Hexagon Urethane Dumbbell 30kg |
| ZSL-DBUX-JA66 | SL Hexagon Urethane Dumbbell 6kg | ZSL-DBUX-JA79 | SL Hexagon Urethane Dumbbell 32kg |
| ZSL-DBUX-JA67 | SL Hexagon Urethane Dumbbell 8kg | ZSL-DBUX-JA80 | SL Hexagon Urethane Dumbbell 34kg |
| ZSL-DBUX-9868 | SL Hexagon Urethane Dumbbell 10kg | ZSL-DBUX-JA81 | SL Hexagon Urethane Dumbbell 36kg |
| ZSL-DBUX-JA69 | SL Hexagon Urethane Dumbbell 12kg | ZSL-DBUX-JA82 | SL Hexagon Urethane Dumbbell 38kg |
| ZSL-DBUX-JA70 | SL Hexagon Urethane Dumbbell 14kg | ZSL-DBUX-JA83 | SL Hexagon Urethane Dumbbell 40kg |
| ZSL-DBUX-JA71 | SL Hexagon Urethane Dumbbell 16kg | ZSL-DBUX-JA84 | SL Hexagon Urethane Dumbbell 42kg |
| ZSL-DBUX-JA72 | SL Hexagon Urethane Dumbbell 18kg | ZSL-DBUX-JA85 | SL Hexagon Urethane Dumbbell 44kg |
| ZSL-DBUX-9872 | SL Hexagon Urethane Dumbbell 20kg | ZSL-DBUX-JA86 | SL Hexagon Urethane Dumbbell 46kg |
| ZSL-DBUX-JA74 | SL Hexagon Urethane Dumbbell 22kg | ZSL-DBUX-JA87 | SL Hexagon Urethane Dumbbell 48kg |
| ZSL-DBUX-JA75 | SL Hexagon Urethane Dumbbell 24kg | ZSL-DBUX-JA88 | SL Hexagon Urethane Dumbbell 50kg |
| ZSL-DBUX-JA76 | SL Hexagon Urethane Dumbbell 26kg | | |

| | | |
|-----------------------|--|---|
| Description | | SL Hexagon Urethane Dumbbells |
| Specifications | | Premium polyurethane surface coating. <i>The SL Hexagon Urethane Dumbbell can only be stored on the ZST-DBST-4967 rack and select Studio Hexagon racks.</i> |
| Handle | | Hard chromed handle (125mm) |
| Color Options | | Black / Grey / White |
| Increments | | 2kg increments |
| Warranty | | Limited 3 year warranty |

SL URETHANE HEXAGON DUMBBELLS (2.5KG INCREMENTS)

The ZIVA® SL Urethane Hexagon Dumbbell updates the old classic with a coat of unparalleled durability. Offered in 2.5kg increments up to 25kg, these dumbbells are made for heavy-duty training. They feature the iconic and necessary no-roll design; straight, fully knurled chrome-finished handles; and large, easy ID weight numbers. Their urethane coat is where they are strongest. This ultra-long-lasting material is scratch- and scuff-proof and gives these dumbbells a wonderfully long lifespan with an undeniably premium look and feel.



| Order Code | Item Description | Order Code | Item Description |
|---------------|-------------------------------------|---------------|-------------------------------------|
| ZSL-DBUX-9865 | SL Hexagon Urethane Dumbbell 2.5kg | ZSL-DBUX-9870 | SL Hexagon Urethane Dumbbell 15kg |
| ZSL-DBUX-9866 | SL Hexagon Urethane Dumbbell 5kg | ZSL-DBUX-9871 | SL Hexagon Urethane Dumbbell 17.5kg |
| ZSL-DBUX-9867 | SL Hexagon Urethane Dumbbell 7.5kg | ZSL-DBUX-9872 | SL Hexagon Urethane Dumbbell 20kg |
| ZSL-DBUX-9868 | SL Hexagon Urethane Dumbbell 10kg | ZSL-DBUX-9873 | SL Hexagon Urethane Dumbbell 22.5kg |
| ZSL-DBUX-9869 | SL Hexagon Urethane Dumbbell 12.5kg | ZSL-DBUX-9874 | SL Hexagon Urethane Dumbbell 25kg |

| | | |
|-----------------------|--|---|
| Description | | SL Hexagon Urethane Dumbbells |
| Specifications | | Premium polyurethane surface coating. <i>The SL Hexagon Urethane Dumbbell can only be stored on the ZST-DBST-4967 rack and select Studio Hexagon racks.</i> |
| Handle | | Hard chromed handle (125mm) |
| Color Options | | Black / Grey / White |
| Increments | | 2.5kg increments |
| Warranty | | Limited 3 year warranty |



XP URETHANE DUMBBELLS

3 YEAR WARRANTY



Solid steel head design with interlocking head to handle

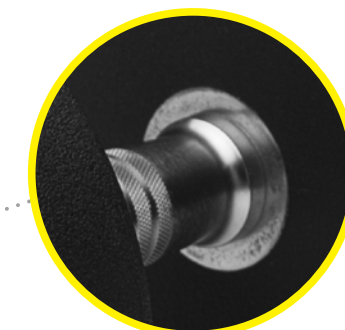

Premium hard chrome contoured handle with stainless steel ring at joint



Large coloured numbers for easy weight size ID

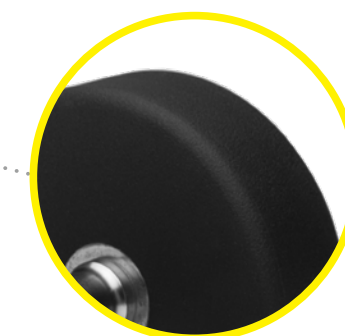

Tested and compliant to RoHS



Premium hard wearing urethane



3 year warranty











XP URETHANE DUMBBELLS (1-10KG)

ZIVA® XP Urethane Dumbbells are the no-nonsense foundation of resistance training. In increments of 1kg from 1-10kg, they are perfect for fast paced, high intensity workouts and warm-ups. They use our most traditional dumbbell design: scratch-proof, chrome-finished handles with grip-assisting knurling along the center of the handle, and solid steel heads coated in long-lasting UV-, corrosion-, and tear-resistant urethane. This coat is a product of modern material science and gives XP Urethane Dumbbells a slight bit of bounce. That means if a dumbbell is dropped during an intense training session, it may be the difference between a dent in the floor or simply a scuff. All in all, these are a timely take on a timeless training classic.



| Order Code | Item Description | Order Code | Item Description |
|--------------------|---|--------------------|---------------------------|
| ZXP-DBPU-4650-GYWT | XP Urethane Dumbbell 1kg | ZXP-DBPU-4655-GYWT | XP Urethane Dumbbell 6kg |
| ZXP-DBPU-4651-GYWT | XP Urethane Dumbbell 2kg | ZXP-DBPU-4656-GYWT | XP Urethane Dumbbell 7kg |
| ZXP-DBPU-4652-GYWT | XP Urethane Dumbbell 3kg | ZXP-DBPU-4657-GYWT | XP Urethane Dumbbell 8kg |
| ZXP-DBPU-4653-GYWT | XP Urethane Dumbbell 4kg | ZXP-DBPU-4658-GYWT | XP Urethane Dumbbell 9kg |
| ZXP-DBPU-4654-GYWT | XP Urethane Dumbbell 5kg | ZXP-DBPU-4659-GYWT | XP Urethane Dumbbell 10kg |
| ZXP-DBPU-1000-GYWT | XP Urethane Studio Dumbbell Set (10 pairs) 1-10kg | | |

| | | |
|----------------------|---|--|
| Description |  | XP Solid Steel Head Urethane Dumbbell |
| Coating |  | Premium urethane surface coating |
| Handle |  | Premium contoured hard chrome handle |
| Increments |  | 1kg increments 1-10kg |
| Color Options |  |  Black /  Grey /  White |
| Warranty |  | Limited 3 year warranty |











XP URETHANE DUMBBELLS (2KG INCREMENTS)

ZIVA® XP Urethane Dumbbells are the no-nonsense foundation of resistance training. In increments of 2kg up to 60kg, they are the go to for heavy-duty workouts. They use our most traditional dumbbell design: scratch-proof, chrome-finished handles with grip-assisting knurling along the center of the handle, and solid steel heads coated in long-lasting UV-, corrosion-, and tear-resistant urethane. This coat is a product of modern material science and gives XP Urethane Dumbbells a slight bit of bounce. That means if a dumbbell is dropped during an intense training session, it may be the difference between a dent in the floor or simply a scuff. All in all, these are a timely take on a timeless training classic.



| Order Code | Item Description | Order Code | Item Description |
|---------------|---------------------------|---------------|---------------------------|
| ZXP-DBPU-8630 | XP Urethane Dumbbell 2kg | ZXP-DBPU-8645 | XP Urethane Dumbbell 32kg |
| ZXP-DBPU-8631 | XP Urethane Dumbbell 4kg | ZXP-DBPU-8646 | XP Urethane Dumbbell 34kg |
| ZXP-DBPU-8632 | XP Urethane Dumbbell 6kg | ZXP-DBPU-8647 | XP Urethane Dumbbell 36kg |
| ZXP-DBPU-8633 | XP Urethane Dumbbell 8kg | ZXP-DBPU-8648 | XP Urethane Dumbbell 38kg |
| ZXP-DBPU-8634 | XP Urethane Dumbbell 10kg | ZXP-DBPU-8649 | XP Urethane Dumbbell 40kg |
| ZXP-DBPU-8635 | XP Urethane Dumbbell 12kg | ZXP-DBPU-8650 | XP Urethane Dumbbell 42kg |
| ZXP-DBPU-8636 | XP Urethane Dumbbell 14kg | ZXP-DBPU-8651 | XP Urethane Dumbbell 44kg |
| ZXP-DBPU-8637 | XP Urethane Dumbbell 16kg | ZXP-DBPU-8652 | XP Urethane Dumbbell 46kg |
| ZXP-DBPU-8638 | XP Urethane Dumbbell 18kg | ZXP-DBPU-8653 | XP Urethane Dumbbell 48kg |
| ZXP-DBPU-8639 | XP Urethane Dumbbell 20kg | ZXP-DBPU-8654 | XP Urethane Dumbbell 50kg |
| ZXP-DBPU-8640 | XP Urethane Dumbbell 22kg | ZXP-DBPU-8615 | XP Urethane Dumbbell 52kg |
| ZXP-DBPU-8641 | XP Urethane Dumbbell 24kg | ZXP-DBPU-8616 | XP Urethane Dumbbell 54kg |
| ZXP-DBPU-8642 | XP Urethane Dumbbell 26kg | ZXP-DBPU-8617 | XP Urethane Dumbbell 56kg |
| ZXP-DBPU-8643 | XP Urethane Dumbbell 28kg | ZXP-DBPU-8618 | XP Urethane Dumbbell 58kg |
| ZXP-DBPU-8644 | XP Urethane Dumbbell 30kg | ZXP-DBPU-8710 | XP Urethane Dumbbell 60kg |

| | | |
|----------------------|---|--|
| Description |  | XP Solid Steel Head Urethane Dumbbell |
| Coating |  | Premium urethane surface coating |
| Handle |  | Premium contoured hard chrome handle |
| Increments |  | 2kg increments |
| Color Options |  |  Black / Grey / White |
| Warranty |  | Limited 3 year warranty |

XP URETHANE BARBELLS

ZIVA® XP Urethane Barbell is an updated yet no-nonsense approach to a pair of timeless classics. These high quality barbells use our most traditional design: scratch-proof, chrome-finished handles with grip-assisting knurling and a knurl-free center, and solid steel heads coated in long-lasting UV-, corrosion-, and tear-resistant urethane with weight IDs prominently displayed on central inserts. This coat is a product of modern material science and gives XP Urethane Barbells a slight bounce if dropped, which may make the difference between a dent in the floor or simply a scuff. All in all, they are a timely take on a timeless training classic.



| Order Code | Item Description | Order Code | Item Description |
|---------------|----------------------------|---------------|--------------------------|
| ZXP-BSPU-8113 | XP Urethane Barbell 10kg | ZXP-BSPU-8118 | XP Urethane Barbell 25kg |
| ZXP-BSPU-8114 | XP Urethane Barbell 12.5kg | ZXP-BSPU-8119 | XP Urethane Barbell 30kg |
| ZXP-BSPU-8115 | XP Urethane Barbell 15kg | ZXP-BSPU-8120 | XP Urethane Barbell 35kg |
| ZXP-BSPU-8116 | XP Urethane Barbell 17.5kg | ZXP-BSPU-8121 | XP Urethane Barbell 40kg |
| ZXP-BSPU-8117 | XP Urethane Barbell 20kg | ZXP-BSPU-8122 | XP Urethane Barbell 45kg |

| | | |
|----------------------|--|---|
| Description | | XP Urethane Barbell |
| Coating | | Premium urethane surface coating |
| Handle | | Premium hard chrome handle |
| Increments | | 2.5kg increments from 10kg - 45kg and 5kg increments from 20-45kg |
| Color Options | | Black / Grey / White |
| Warranty | | Limited 3 year warranty |

XP URETHANE EZ CURL BARBELLS

ZIVA® XP Urethane EZ Curl Barbell are an updated yet no-nonsense approach to a pair of timeless classics. These high quality barbells use our most traditional design: scratch-proof, chrome-finished handles with grip-assisting knurling and a knurl-free center, and solid steel heads coated in long-lasting UV-, corrosion-, and tear-resistant urethane with weight IDs prominently displayed on central inserts. This coat is a product of modern material science and gives XP Urethane EZ Curl Barbells a slight bounce if dropped, which may make the difference between a dent in the floor or simply a scuff. All in all, they are a timely take on a timeless training classic.



| Order Code | Item Description | Order Code | Item Description |
|---------------|------------------------------------|---------------|----------------------------------|
| ZXP-BCPU-8128 | XP Urethane EZ Curl Barbell 10kg | ZXP-BCPU-8133 | XP Urethane EZ Curl Barbell 25kg |
| ZXP-BCPU-8129 | XP Urethane EZ Curl Barbell 12.5kg | ZXP-BCPU-8134 | XP Urethane EZ Curl Barbell 30kg |
| ZXP-BCPU-8130 | XP Urethane EZ Curl Barbell 15kg | ZXP-BCPU-8135 | XP Urethane EZ Curl Barbell 35kg |
| ZXP-BCPU-8131 | XP Urethane EZ Curl Barbell 17.5kg | ZXP-BCPU-8136 | XP Urethane EZ Curl Barbell 40kg |
| ZXP-BCPU-8132 | XP Urethane EZ Curl Barbell 20kg | ZXP-BCPU-8137 | XP Urethane EZ Curl Barbell 45kg |

| | | |
|----------------------|--|---|
| Description | | XP Urethane EZ Curl Barbell |
| Coating | | Premium urethane surface coating |
| Handle | | Premium hard chrome handle |
| Increments | | 2.5kg increments from 10kg - 45kg and 5kg increments from 20-45kg |
| Color Options | | Black / Grey / White |
| Warranty | | Limited 3 year warranty |



SL RPU DUMBBELLS

2 YEAR WARRANTY



Solid steel head design with interlocking head to handle

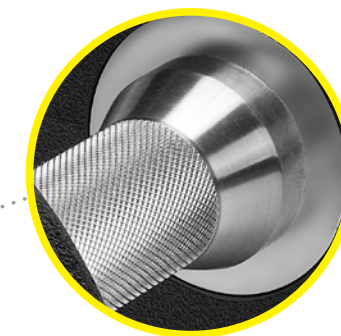

Chrome straight handle with stainless steel ring at joint



Large coloured numbers for easy weight size ID



Tested and compliant to RoHS



Premium RPU coating (Rubber Polyurethane)

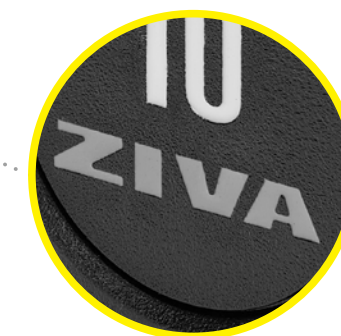

2 year warranty









SL RPU DUMBBELLS (1-10KG)

ZIVA® SL RPU Dumbbells update timeless dumbbell design with a marvel of modern material science: RPU. This coat, which serves as a protective cover on the dumbbells' solid steel heads, combines the bounce of rubber - a crucial quality for protecting the weights, gym floors, and users - and the ultra-high durability of urethane, making them UV-, corrosion-, water-, scratch-, and tear-resistant, as well as longer lasting than any competitor in its class. Scratch-proof, chrome-finished handles with grip-assisting knurling along the center of the handle give excellent usability and large, easy ID weight numbers means they also look as good as they perform. In 1kg increments from 1-10kg, these dumbbells are perfect for fast paced workouts and warm-ups.



| Order Code | Item Description | Order Code | Item Description |
|--------------------|--|--------------------|---------------------------------|
| ZSL-RPDB-TC53-GYWT | SL RPU Studio Dumbbell Set 1kg | ZSL-RPDB-TC58-GYWT | SL RPU Studio Dumbbell Set 6kg |
| ZSL-RPDB-TC54-GYWT | SL RPU Studio Dumbbell Set 2kg | ZSL-RPDB-TC59-GYWT | SL RPU Studio Dumbbell Set 7kg |
| ZSL-RPDB-TC55-GYWT | SL RPU Studio Dumbbell Set 3kg | ZSL-RPDB-TC60-GYWT | SL RPU Studio Dumbbell Set 8kg |
| ZSL-RPDB-TC56-GYWT | SL RPU Studio Dumbbell Set 4kg | ZSL-RPDB-TC61-GYWT | SL RPU Studio Dumbbell Set 9kg |
| ZSL-RPDB-TC57-GYWT | SL RPU Studio Dumbbell Set 5kg | ZSL-RPDB-TC62-GYWT | SL RPU Studio Dumbbell Set 10kg |
| ZSL-RPDB-TC52-GYWT | SL RPU Studio Dumbbell Set 1-10kg (10 pairs) | | |

| | | |
|-----------------------|---|--|
| Description |  | SL RPU Dumbbells |
| Specifications |  | Premium rubberized polyurethane surface coating |
| Handle |  | Chromed handle |
| Color Options |  |  Black / Grey / White |
| Increments |  | 1kg increments |
| Warranty |  | Limited 2 year warranty |

SL RPU DUMBBELLS (2KG INCREMENTS)

ZIVA® SL RPU Dumbbells update timeless dumbbell design with a marvel of modern material science: RPU. This coat, which serves as a protective cover on the dumbbells' solid steel heads, combines the bounce of rubber - a crucial quality for protecting the weights, gym floors, and users - and the ultra-high durability of urethane, making them UV-, corrosion-, water-, scratch-, and tear-resistant, as well as longer lasting than any competitor in its class. Scratch-proof, chrome-finished handles with grip-assisting knurling along the center of the handle give excellent usability and large, easy ID weight numbers means they also look as good as they perform. In 2.5kg increments up to 50kg, these dumbbells are perfect for heavy-duty workouts. When combined with the 2kg increment dumbbells, they allow for the cutting-edge scientific progressive training.



| Order Code | Item Description | Order Code | Item Description |
|---------------|----------------------|---------------|----------------------|
| ZSL-RPDB-TC63 | SL RPU Dumbbell 2kg | ZSL-RPDB-TC76 | SL RPU Dumbbell 28kg |
| ZSL-RPDB-TC64 | SL RPU Dumbbell 4kg | ZSL-RPDB-8472 | SL RPU Dumbbell 30kg |
| ZSL-RPDB-TC65 | SL RPU Dumbbell 6kg | ZSL-RPDB-TC78 | SL RPU Dumbbell 32kg |
| ZSL-RPDB-TC66 | SL RPU Dumbbell 8kg | ZSL-RPDB-TC79 | SL RPU Dumbbell 34kg |
| ZSL-RPDB-8456 | SL RPU Dumbbell 10kg | ZSL-RPDB-TC80 | SL RPU Dumbbell 36kg |
| ZSL-RPDB-TC68 | SL RPU Dumbbell 12kg | ZSL-RPDB-TC81 | SL RPU Dumbbell 38kg |
| ZSL-RPDB-TC69 | SL RPU Dumbbell 14kg | ZSL-RPDB-8476 | SL RPU Dumbbell 40kg |
| ZSL-RPDB-TC70 | SL RPU Dumbbell 16kg | ZSL-RPDB-TC83 | SL RPU Dumbbell 42kg |
| ZSL-RPDB-TC71 | SL RPU Dumbbell 18kg | ZSL-RPDB-TC84 | SL RPU Dumbbell 44kg |
| ZSL-RPDB-8460 | SL RPU Dumbbell 20kg | ZSL-RPDB-TC85 | SL RPU Dumbbell 46kg |
| ZSL-RPDB-TC73 | SL RPU Dumbbell 22kg | ZSL-RPDB-TC86 | SL RPU Dumbbell 48kg |
| ZSL-RPDB-TC74 | SL RPU Dumbbell 24kg | ZSL-RPDB-8480 | SL RPU Dumbbell 50kg |
| ZSL-RPDB-TC75 | SL RPU Dumbbell 26kg | | |

| | | |
|-----------------------|--|---|
| Description | | SL RPU Dumbbells |
| Specifications | | Premium rubberized polyurethane surface coating |
| Handle | | Chromed handle |
| Color Options | | Black / Grey / White |
| Increments | | 2kg increments |
| Warranty | | Limited 2 year warranty |









SL RPU DUMBBELLS (2.5KG INCREMENTS)

ZIVA® SL RPU Dumbbells update timeless dumbbell design with a marvel of modern material science: RPU. This coat, which serves as a protective cover on the dumbbells' solid steel heads, combines the bounce of rubber - a crucial quality for protecting the weights, gym floors, and users - and the ultra-high durability of urethane, making them UV-, corrosion-, water-, scratch-, and tear-resistant, as well as longer lasting than any competitor in its class. Scratch-proof, chrome-finished handles with grip-assisting knurling along the center of the handle give excellent usability and large, easy ID weight numbers means they also look as good as they perform. In 2kg increments up to 50kg, these dumbbells are perfect for heavy-duty workouts. When combined with the 2.5kg increment dumbbells, they allow for the cutting-edge scientific progressive training.

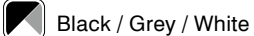

| Order Code | Item Description | Order Code | Item Description |
|---------------|------------------------|---------------|------------------------|
| ZSL-RPDB-8453 | SL RPU Dumbbell 2.5kg | ZSL-RPDB-8471 | SL RPU Dumbbell 27.5kg |
| ZSL-RPDB-8454 | SL RPU Dumbbell 5kg | ZSL-RPDB-8472 | SL RPU Dumbbell 30kg |
| ZSL-RPDB-8455 | SL RPU Dumbbell 7.5kg | ZSL-RPDB-8473 | SL RPU Dumbbell 32.5kg |
| ZSL-RPDB-8456 | SL RPU Dumbbell 10kg | ZSL-RPDB-8474 | SL RPU Dumbbell 35kg |
| ZSL-RPDB-8457 | SL RPU Dumbbell 12.5kg | ZSL-RPDB-8475 | SL RPU Dumbbell 37.5kg |
| ZSL-RPDB-8458 | SL RPU Dumbbell 15kg | ZSL-RPDB-8476 | SL RPU Dumbbell 40kg |
| ZSL-RPDB-8459 | SL RPU Dumbbell 17.5kg | ZSL-RPDB-8477 | SL RPU Dumbbell 42.5kg |
| ZSL-RPDB-8460 | SL RPU Dumbbell 20kg | ZSL-RPDB-8478 | SL RPU Dumbbell 45kg |
| ZSL-RPDB-8461 | SL RPU Dumbbell 22.5kg | ZSL-RPDB-8479 | SL RPU Dumbbell 47.5kg |
| ZSL-RPDB-8462 | SL RPU Dumbbell 25kg | ZSL-RPDB-8480 | SL RPU Dumbbell 50kg |

| | | |
|-----------------------|---|--|
| Description |  | SL RPU Dumbbells |
| Specifications |  | Premium rubberized polyurethane surface coating |
| Handle |  | Chromed handle |
| Color Options |  |  Black / Grey / White |
| Increments |  | 2.5kg increments |
| Warranty |  | Limited 2 year warranty |

SL RPU BARBELLS

ZIVA® SL RPU Barbell is a timeless classic updated with a marvel of modern material science: RPU. Its RPU coat serves as a protective cover on the barbells' solid steel heads and combines the bounce of rubber - a crucial quality for protecting the weights, gym floors, and users - and the ultra-high durability of urethane, making them UV-, corrosion-, water-, scratch-, and tear-resistant, as well as longer lasting than any competitor in its class. Scratch-proof, chrome-finished bars with grip-assisting knurling and a knurl-free center make for excellent usability, and large, easy ID weight numbers means these barbells also look as good as they perform.



| Order Code | Item Description | Order Code | Item Description |
|---------------|-----------------------|---------------|---------------------|
| ZSL-RPBB-8874 | SL RPU Barbell 10kg | ZSL-RPBB-8879 | SL RPU Barbell 25kg |
| ZSL-RPBB-8875 | SL RPU Barbell 12.5kg | ZSL-RPBB-8880 | SL RPU Barbell 30kg |
| ZSL-RPBB-8876 | SL RPU Barbell 15kg | ZSL-RPBB-8881 | SL RPU Barbell 35kg |
| ZSL-RPBB-8877 | SL RPU Barbell 17.5kg | ZSL-RPBB-8882 | SL RPU Barbell 40kg |
| ZSL-RPBB-8878 | SL RPU Barbell 20kg | ZSL-RPBB-8883 | SL RPU Barbell 45kg |

| | | |
|-----------------------|--|---|
| Description | | SL RPU Barbells |
| Specifications | | Premium rubberized polyurethane surface coating |
| Handle | | Chromed handle |
| Color Options | | Black / Grey / White |
| Increments | | 2.5kg increments from 10kg - 20kg and 5kg increments from 20-45kg |
| Warranty | | Limited 2 year warranty |

SL RPU EZ CURL BARBELLS

ZIVA® SL RPU EZ Curl Barbell is another timeless classic updated with a marvel of modern material science: RPU. Its RPU coat serves as a protective cover on the barbells' solid steel heads and combines the bounce of rubber - a crucial quality for protecting the weights, gym floors, and users - and the ultra-high durability of urethane, making them UV-, corrosion-, water-, scratch-, and tear-resistant, as well as longer lasting than any competitor in its class. Scratch-proof, chrome-finished bars, bent to take pressure off users' wrists, feature grip-assisting knurling and a knurl-free center for excellent usability, and large, easy ID weight numbers means these barbells also look as good as they perform.



| Order Code | Item Description | Order Code | Item Description |
|---------------|-------------------------------|---------------|-----------------------------|
| ZSL-RPEZ-8887 | SL RPU EZ Curl Barbell 10kg | ZSL-RPEZ-8892 | SL RPU EZ Curl Barbell 25kg |
| ZSL-RPEZ-8888 | SL RPU EZ Curl Barbell 12.5kg | ZSL-RPEZ-8893 | SL RPU EZ Curl Barbell 30kg |
| ZSL-RPEZ-8889 | SL RPU EZ Curl Barbell 15kg | ZSL-RPEZ-8894 | SL RPU EZ Curl Barbell 35kg |
| ZSL-RPEZ-8890 | SL RPU EZ Curl Barbell 17.5kg | ZSL-RPEZ-8895 | SL RPU EZ Curl Barbell 40kg |
| ZSL-RPEZ-8891 | SL RPU EZ Curl Barbell 20kg | ZSL-RPEZ-8896 | SL RPU EZ Curl Barbell 45kg |

| | | |
|-----------------------|--|---|
| Description | | SL RPU EZ Curl Barbells |
| Specifications | | Premium rubberized polyurethane surface coating |
| Handle | | Chromed handle |
| Color Options | | Black / Grey / White |
| Increments | | 2.5kg increments from 10kg - 20kg and 5kg increments from 20-45kg |
| Warranty | | Limited 2 year warranty |

SL RPU GRIP DISC

The ZIVA® SL RPU Grip Disc wraps our precision cast iron weight disc in ultra-high durability RPU that combines the renowned ruggedness of urethane with the slight bounce of rubber, making it perfect for protecting the weights as well as the surrounding gym. Made to fit any standard Olympic bar, the SL RPU Grip Disc is scratch-, wear-, and rust-resistant and features beveled edges, large weight ID numbers, and handles that make loading and unloading easy.



| Order Code | Item Description | Order Code | Item Description |
|--------------------|-------------------------|--------------------|-----------------------|
| ZSL-DCPU-2640-GYWT | SL RPU Grip Disc 1.25kg | ZSL-DCPU-2644-GYWT | SL RPU Grip Disc 15kg |
| ZSL-DCPU-2641-GYWT | SL RPU Grip Disc 2.5kg | ZSL-DCPU-2645-GYWT | SL RPU Grip Disc 20kg |
| ZSL-DCPU-2642-GYWT | SL RPU Grip Disc 5kg | ZSL-DCPU-2646-GYWT | SL RPU Grip Disc 25kg |
| ZSL-DCPU-2643-GYWT | SL RPU Grip Disc 10kg | | |



| | | |
|----------------------|---|--|
| Description |  | SL RPU Grip Disc |
| Coating |  | Premium rubberized polyurethane surface coating |
| Color Options |  |  Black / Grey / White |
| Increments |  | 1.25kg, 2.5kg and 5kg increments from 5kg - 25kg |
| Warranty |  | Limited 2 year warranty |

SL URETHANE GRIP DISCS

ZIVA® SL Urethane Grip Discs feature precision cast iron wrapped in ultra-long-lasting UV-, water-, and tear-resistant urethane that stays looking newer for longer. These sleek, stylishly design weight discs with large, easy ID numbering are made to fit standard Olympic bars and are available in 1.25kg and 2.5kg sizes, and in 5kg increments from 5-25kg. They are the building blocks that great free weight sections are made of.



| Order Code | Item Description | Order Code | Item Description |
|---------------|------------------------------|---------------|----------------------------|
| ZSL-DCPU-3961 | SL Urethane Grip Disc 1.25kg | ZSL-DCPU-3965 | SL Urethane Grip Disc 15kg |
| ZSL-DCPU-3962 | SL Urethane Grip Disc 2.5kg | ZSL-DCPU-3966 | SL Urethane Grip Disc 20kg |
| ZSL-DCPU-3963 | SL Urethane Grip Disc 5kg | ZSL-DCPU-3967 | SL Urethane Grip Disc 25kg |
| ZSL-DCPU-3964 | SL Urethane Grip Disc 10kg | | |

| | | |
|----------------------|---|---|
| Description |  | SL Urethane Grip Disc |
| Coating |  | Premium urethane surface coating |
| Color Options |  |  Black / Yellow / Grey |
| Increments |  | 1.25kg, 2.5kg and 5kg increments from 5kg - 25kg |
| Warranty |  | Limited 4 year warranty |

ZIVA

ZIVA

10

05

8
ZIVA

12
ZIVA

16
ZIVA

20
ZIVA

24
ZIVA

08

10

12

15

20

15
ZIVA

20
ZIVA

4
ZIVA

8
ZIVA

12
ZIVA

16
ZIVA

24
ZIVA



A man is lying on a black ZIVA bench press machine, performing a bench press. He is wearing a black t-shirt and is looking upwards. The machine has a black barbell with weights on either side. The weights are black with 'ZIVA' and '20' or '10' printed on them. The background is a white wall with a textured pattern.

BENCHES

Great training programs are built on the stability, safety, and impeccable form provided by great benches, and the form of these benches carry ZIVA's impeccable aesthetics, as well.

Great benches are the backbone of every great workout program, and ZIVA's benches provide not only the stability of our always excellent construction, but also a beautiful aesthetic and cushioned comfort, as well. All ZIVA benches come from the EX Series and feature firm, double-stitched cushions and floor-protecting foot pads on their ultra-sturdy frames, bringing an unparalleled level of safety to a wide range of exercises. Not only a variety of bench presses, but shoulder, back, arm, and other exercises.



EX F-I-D BENCH 2.0

The ZIVA® EX F-I-D Bench 2.0 is a best-in-class, uniquely designed wonder of versatility, stability, and comfort. With 2x points of adjustment at the seat bottom and back, this F-I-D Bench allows users to enjoy a wide variety of chest, shoulder, and other exercises in the utmost security and safety, and thanks to its high-quality cushions with high durability double stitching, they can enjoy the utmost comfort, as well.



Order Code
ZEX-XFID-6762

Item Description
EX F-I-D Bench 2.0

| | | |
|-----------------------|--|---|
| Description | | EX F-I-D Bench 2.0 |
| Specifications | | 3.0mm thick steel frame, adjustable seat bottom (0-30°) & back (-10-80°), cushioned rubber feet or bolt down option, high quality cushion surface with double stitches for better stability |
| Weight Loading | | 200kg |
| Product Color | | Black powder-coated finish |
| Dimensions | | 140cm x 70cm x 45cm - 40kg |
| Warranty | | Limited 10 year warranty on frames and welding, 1 year on plastic parts, 90 days on pads |

EX FLAT BENCH 2.0

The ZIVA® EX Flat Bench 2.0, with its unmistakable design, high quality double-stitched cushion, and supremely stable structure, is the best-in-class choice for any fixed flat bench. It features a 3mm thick steel frame with scratch-, rust-, and wear-resistant black powder coating that makes it exceedingly durable, so it stays looking newer for longer despite the rigorous environments of heavy weight areas in high-traffic commercial gyms.



Order Code
ZEX-XFLT-6752

Item Description
EX Flat Bench 2.0

| | | |
|-----------------------|--|--|
| Description | | EX Flat Bench 2.0 |
| Specifications | | 3.0mm thick steel frame, cushioned rubber feet with bolt down option, high quality cushion surface with double stitches for better stability |
| Weight Loading | | 200kg |
| Product Color | | Black powder-coated finish |
| Dimensions | | 135cm x 80cm x 40cm - 30kg |
| Warranty | | Limited 10 year warranty on frames and welding, 1 year on plastic parts, 90 days on pads |

EX ABDOMINAL BENCH 2.0

The ZIVA® EX Abdominal Bench 2.0, adjustable to a 30° incline, is a marvel of minimalist design. The ergonomically designed, firm yet comfortable cushions for the back knees and ankles guarantee that users can keep going until reaching muscle fatigue. Easy to move about the gym thanks to attached PU wheels, this workout mainstay challenges users' cores without challenging their tolerance for discomfort.



Order Code
ZEX-XABD-6763

Item Description
EX Abdominal Bench 2.0

| | | |
|-----------------------|--|--|
| Description | | EX Abdominal Bench 2.0 |
| Specifications | | 3.0mm thick steel frame, 30° back angle for comfort and safety, cushioned rubber feet with bolt down option and high quality cushion surface with double stitches for better stability |
| Weight Loading | | 200kg |
| Product Color | | Black powder-coated finish |
| Dimensions | | 127cm x 63cm x 83cm - 32kg |
| Warranty | | Limited 10 year warranty on frames and welding, 1 year on plastic parts, 90 days on pads |

EX SCOTT CURL BENCH 2.0

The ZIVA® EX Scott Curl Bench 2.0 lets users lock arms into perfect position for intense, targeted arm exercises performed with forced flawless technique thanks to its design. The bench's heavy steel frame and floor-gripping and -protecting rubber feet ensure stability regardless of the weight lifted, while its high quality cushions for arms and on the adjustable seat ensure comfort throughout. A bench uniquely designed to help grow arm strength, the Scott Curl Bench 2.0 is a must for any gym's free weight zone. And it's not just functional. This bench, like all our equipment, uses ZIVA's aesthetic design to lend its surroundings a high-end feel while remaining an economical choice.



Order Code
ZEX-XSCT-6758

Item Description
EX Scott Curl Bench 2.0

| | | |
|-----------------------|--|---|
| Description | | EX Scott Curl Bench 2.0 |
| Specifications | | 3.0mm thick steel frame, cushioned rubber feet with bolt down option, hard-wearing padding, adjustable seat height to enable multiple exercise positions, and hard-wearing PU padding and strips to protect the metal surfaces and barbell knurling |
| Weight Loading | | 200kg |
| Product Color | | Black powder-coated finish |
| Dimensions | | 140cm x 90cm x 90cm - 65kg |
| Warranty | | Limited 10 year warranty on frames; 90 days on pads |



EX HYPER EXTENSION BENCH 2.0

The ZIVA® EX Hyper Extension Bench 2.0 provides the ultimate stability for back-bending exercises. Its floor-gripping rubber feet keep it firmly in place even as users adjust the high quality cushion height and lock in on the polished steel foot plate or use the built-in bars. Easy to move about the gym thanks to its attached PU wheels, the Hyper Extension Bench 2.0 goes where it's needed, whether by the squat rack or lifting platform for extra powerlifting accessory work, by the warm-up and stretching zone for core and flexibility work, or anywhere else it comes in handy. However it's used, this bench's features and looks elevate the typical hyper extension platform and manage to lift the surrounding gym environment, too.



Order Code
ZEX-XHEX-6764

Item Description
EX Hyper Extension Bench 2.0

| | | |
|-----------------------|--|--|
| Description | | EX Hyper Extension Bench 2.0 |
| Specifications | | 3.0mm thick steel frame, cushioned rubber feet with bolt down option, adjustable pad height and high quality cushion surface with double stitches for better stability |
| Weight Loading | | 200kg |
| Product Color | | Black powder-coated finish |
| Dimensions | | 138.3cm x 88.5cm x 81.1cm - 65kg |
| Warranty | | Limited 10 year warranty on frames; 90 days on pads |

EX UTILITY BENCH 2.0

The ZIVA® EX Utility Bench 2.0 offers the sturdiest, most secure seat in the gym, so users can feel confident and comfortable when they are ready to push themselves. Its heavy-duty, 3mm thick steel frame supports a high quality, double-stitched cushioned back and seat, delivering comfort even under tough loads. And despite its unmatched stability, it moves easily around the gym thanks to wheels at the back and a urethane coated handle at the front.



Order Code
ZEX-XUTL-6759

Item Description
EX Utility Bench 2.0

| | | |
|-----------------------|--|--|
| Description | | EX Utility Bench 2.0 |
| Specifications | | 3.0mm thick steel frame, 30° back angle for comfort and safety, cushioned rubber feet with bolt down option and high quality cushion surface with double stitches for better stability |
| Weight Loading | | 200kg |
| Product Color | | Black powder-coated finish |
| Dimensions | | 95cm x 85cm x 130cm - 40kg |
| Warranty | | Limited 10 year warranty on frames and welding, 1 year on plastic parts, 90 days on pads |







EX OLYMPIC DECLINE BENCH

Designed to handle elite athletes' training loads, the EX Olympic Decline Bench embodies ZIVA®'s commitment to excellent performance and eye-catching aesthetics. Crafted with robust steel tubing and plate finished with a rust- and scratch-resistant black powder coat, it's made to last in high traffic, high intensity commercial gym settings. Its sturdy yet comfortable foam bench, wrapped in a sleek, leather-textured PVC skin, sits at a 20-degree decline perfect for targeting the lower pectoral muscles while an adjustable padded leg holder further enhances safety, stability, and comfort. The inclusion of 6x chrome-coated storage posts for weight plates maximizes efficient use of gym space, making this an indispensable piece for any gym.



Order Code
ZEX-DCBP-TP07

Item Description
EX Olympic Decline Bench

| | | |
|-----------------------|---|---|
| Description |  | EX Olympic Decline Bench |
| Specifications |  | Made from 3mm thick steel tubing with 6 stainless steel storage posts, uses locking bolts, extra stable rubber footpads, PU protectors on the racking slats, and features a double-stitched inner pad of PU foam. |
| Product Color |  |  Black powder-coated finish |
| Dimensions |  | 171cm x 184cm 129cm - 102kg |
| Warranty |  | Limited 10 year warranty on frames and welding, 1 year on plastic parts |







EX OLYMPIC INCLINE BENCH

The ZIVA® EX Olympic Incline Bench is a must-have for any facility hoping for a thriving membership of strength, power, and bodybuilding enthusiasts with a structure of heavy-duty steel tube finished with a rust- and scratch-resistant black powder coat, is built to endure the rigors of heavy use and heavy traffic while maintaining a sleek, premium look. Set at a precise 45-degree angle for optimal upper pectoral engagement, it features an adjustable, foam-padded seat and bench wrapped in a durable, double-stitched leather-textured PVC skin. It comes equipped with 6x built-in chrome-coated storage posts for weight plates, enhancing convenience and safety. The addition of a steel plate for spotters to stand on ensures an extra layer of security during intense lifting sessions.



Order Code
ZEX-ICBP-TP08

Item Description
EX Olympic Incline Bench

| | | |
|-----------------------|---|---|
| Description |  | EX Olympic Decline Bench |
| Specifications |  | Made from 3mm thick steel tubing with 6 stainless steel storage posts, uses locking bolts, extra stable rubber footpads, PU protectors on the racking slats, features a double-stitched inner pad of PU foam, and uses a new, smoother operating technology for shifting the seat's position. |
| Product Color |  |  Black powder-coated finish |
| Dimensions |  | 171cm x 166cm x 154cm - 137kg |
| Warranty |  | Limited 10 year warranty on frames and welding, 1 year on plastic parts |







EX OLYMPIC FLAT BENCH

The all-new ZIVA® EX Olympic Flat Bench combines one of the most traditional strength training essentials with an unrivaled aesthetic that elevates its surroundings. The structure is crafted from thick steel tubing and plate, ensuring durable stability regardless of workout intensity while the Bench's surface, a high-density foam pad wrapped in double-stitched, leather-textured PVC skin, offers superior comfort and longevity. Designed to cater to the serious strength trainer, powerlifter, and bodybuilder, this bench also features 6x chrome-plated storage posts for weight discs, so sets progress smoothly and efficiently.



Order Code
ZEX-FLBP-TP06

Item Description
EX Olympic Flat Bench

| | | |
|-----------------------|---|---|
| Description |  | EX Olympic Flat Bench |
| Specifications |  | Made from 3mm thick steel tubing with 6 stainless steel storage posts, uses locking bolts, extra stable rubber footpads, PU protectors on the racking slats, and features a double-stitched inner pad of PU foam. |
| Product Color |  | <input checked="" type="checkbox"/> Black powder-coated finish |
| Dimensions |  | 171cm x 160cm x 137cm - 98kg |
| Warranty |  | Limited 10 year warranty on frames and welding, 1 year on plastic parts |





MULTI-GRIP KNEE RAISE/DIP/PULL-UP STATION

The ZIVA® Multi-Grip Knee Raise/Dip/Pull-up Station is the ultimate in stability for a variety of bodyweight exercises. Crafted from heavy-duty steel tubing and coated with a rust- and scratch-resistant black powder, this versatile station is built for every commercial gym setting. Its ergonomically designed arm pads provide a comfortable base while its reduced profile back pad allows for greater range of motion. All pads are made from durable hard foam and enveloped in double-stitched, leather-textured PVC skin, promising both comfort and durability. Equipped with non-slip grips for knee raises and dips, and offering both wide and close grips for pull-ups, this station caters to users of all skill levels.



Order Code
ZXP-VKRG-TP23

Item Description
Multi-Grip Knee Raise/Dip/Pull-up Station

| | | |
|-----------------------|---|--|
| Description |  | Multi-Grip Knee Raise/Dip/Pull-up Station |
| Specifications |  | Made from 3mm thick steel tubing, double-stitched padding, 3x pairs of differently angled grips, and extra stable rubber footpads. |
| Product Color |  |  Black powder-coated finish |
| Dimensions |  | 127cm x 111cm x 238cm - 118kg |
| Warranty |  | Limited 10 year warranty on frames and welding, 1 year on plastic parts |







HIP THRUST STATION

The ZIVA® Hip Thrust Station is a no-nonsense glute and hamstring training platform that will greatly enhance users' strength for deadlifts, squats, and Olympic lifts. This Hip Thrust Station's innovative design includes an angled foot base and an adjustable angle back pad, made from dense foam and encased in durable PVC skin that allows for comfort even during intense training sessions. The raised bar rests enable easier workout setup for users of all sizes while the 4x resistance band pegs allow for custom weight loading that changes the dynamic of the lift.



Order Code
ZXP-HTSB-TP14

Item Description
Hip Thrust Station

| Description | Item Description |
|--|--|
|  Hip Thrust Station | Hip Thrust Station |
|  Specifications | Made with a steel anti-slip foot plate, 3mm thick steel tubing, locking bolts, double-stitched padding on the adjustable back pad, 8x stainless steel resistance band pegs, PU protectors on the lift-off bars, and PU wheels for easy mobility. |
|  Product Color |  Black powder-coated finish |
|  Dimensions | 85cm x 176cm x 52cm - 100kg |
|  Warranty | Limited 10 year warranty on frames and welding, 1 year on plastic parts |

STORAGE

Storage solutions that serve double duty as organizational hubs to safely, securely store all manner of pieces, and as showcases on which to display ZIVA®'s terrific designs and artful equipment.



All of our storage solutions are crafted from unbreakable, unshakable steel and PVC, and come with a black powder coat that is corrosion and scratch-resistant so they stay looking attractive and new for years, even in the highest traffic environments. We offer a range of designs to meet the needs of all kinds of aesthetics.

Our EX Series offers our sleekest, most modern designs and materials, and the ST and ST2 Series deliver a unique and unmistakable curved rack, while the XP Series brings no-nonsense dumbbell storage and highly versatile, highly flexible multi-functional storage racks. But all ZIVA® storage options speak the same design language as the rest of our equipment, leading to a unified look and feel that lends their surroundings an inspiring air.





“

Smart Fit selected ZIVA to be our official and strategic partner in Brazil and all over Latin America. The ZIVA combination of innovative designs, excellent product quality and service is a winning combination for us at Smart Fit all over the continent.

Thiago Somera

Supply Chain Director

”



EX 5-PAIR HORIZONTAL DUMBBELL RACK 2.0

The ZIVA EX 5-Pair Horizontal Dumbbell Rack 2.0 is a best-in-class storage solution that keeps gyms uncluttered and pristine, and doubles as a beautiful display rack to show off beautiful round-head dumbbells. Glass-filled grey nylon saddles sit atop grey powder-coated steel tubes and serve as protective cradles for dumbbells. The tubes are held aloft by welded steel plate, creating a minimalist profile that is the perfect marriage of form and function. The undeniably premium look of this Rack can be customized by swapping out the grey panels, giving gyms the ability to define their own standards for beautiful organization.



Order Code
ZEX-DB05-7312

Item Description
EX 5-Pair Horizontal Dumbbell Rack 2.0

| | | |
|-----------------------|--|---|
| Description | | EX 5-Pair Horizontal Dumbbell Rack 2.0 |
| Specifications | | Made with thick plate welded steel with reinforced load bearing internally, and -branded boards front and back. 89mm tubes support glass-filled nylon saddles |
| Product Color | | Metallic black powder-coated finish with black panels |
| Storage | | Fits 5-pairs of round-head dumbbells |
| Dimensions | | 145cm x 82cm x 65cm - 65kg |
| Warranty | | Limited 10 year warranty on frames; 1 year on saddles |

EX 10-PAIR HORIZONTAL DUMBBELL RACK 2.0

The ZIVA EX 5-Pair Horizontal Dumbbell Rack 2.0 doubles the best-in-class storage of the 5-Pair Rack to keep free weight areas organized and show off an even more extensive range of beautiful round-head dumbbells. Glass-filled grey nylon saddles sit atop grey powder-coated steel tubes and serve as protective cradles for dumbbells. The tubes are held aloft by welded steel plate, creating a minimalist profile that is the perfect marriage of form and function. The undeniably premium look of this Rack can be customized by swapping out the grey panels, giving gyms the ability to define their own standards for beautiful organization.



Order Code
ZEX-DB10-7311

Item Description
EX 10-Pair Horizontal Dumbbell Rack 2.0

| | | |
|-----------------------|--|---|
| Description | | EX 10-Pair Horizontal Dumbbell Rack 2.0 |
| Specifications | | Made with thick plate welded steel with reinforced load bearing internally, and -branded boards front and back. 89mm tubes support glass-filled nylon saddles |
| Product Color | | Metallic black powder-coated finish with black panels |
| Storage | | Fits 10-pairs of round-head dumbbells |
| Dimensions | | 257cm x 82cm x 65cm - 105kg |
| Warranty | | Limited 10 year warranty on frames; 1 year on saddles |

EX 10-PIECE BARBELL RACK 2.0

The ZIVA EX 10-Piece Barbell Rack 2.0 keeps barbells perfectly arranged and has an unmistakably artful look thanks to its signature curved design. Crafted from powder-coated thick oval steel tubing with glass-filled grey nylon saddles that offer barbells a protective cradle, this Rack is made to handle exhausted users' slamming weights down without taking a nick, dent, or scratch. With floor-protecting footpads, it safeguards the surroundings, the weights, and users themselves. The Rack's undeniably premium look can be customized by swapping out its grey panels, giving gyms the ability to define their own standards for beautiful organization.



Order Code
ZEX-BB10-7315

Item Description
EX 10 Piece Barbell Rack 2.0

| | | |
|-----------------------|--|--|
| Description | | EX 10 Piece Barbell Rack 2.0 |
| Specifications | | Made with thick plate welded steel reinforced frame, branded boards front and back with chrome-colored hardware and glass filled nylon saddles |
| Product Color | | Metallic black powder-coated finish with black panels |
| Storage | | Fits 10-barbells or EZ curl bars |
| Dimensions | | 86cm x 122cm x 79cm - 60kg |
| Warranty | | Limited 10 year warranty on frames; 1 year on saddles |

EX DISC STORAGE STATION 2.0

The ZIVA EX Disc Storage Station 2.0 is an organizational and design masterpiece that looks as much like a modern art piece as it does a piece of gym equipment. The Storage Station 2.0 is crafted from thick steel plate, scratch-resistant polished steel storage posts, and grey panels that can be customized with the most detailed logo and any Pantone color. Its economical use of floor space means it fits most anywhere but with its fashionable profile you may want it front and center.



Order Code
ZEX-DTVS-7314

Item Description
EX Disc Storage Station 2.0

| | | |
|-----------------------|--|---|
| Description | | EX Disc Storage Station 2.0 |
| Specifications | | Made with thick plate welded steel reinforced frame, branded boards front and back with chrome colored hardware and polished steel storage spindles |
| Product Color | | Metallic black powder-coated finish with black panels |
| Storage | | Fits all ZIVA Grip Discs |
| Dimensions | | 71cm x 124cm x 42cm - 45kg |
| Warranty | | Limited 10 year warranty on frames and welding, 1 year on plastic parts |









EX 1 - 10KG VERTICAL STUDIO DUMBBELL RACK 2.0

The ZIVA EX 1-10KG Vertical Studio Dumbbell Rack 2.0 is an organizational and design masterpiece that looks perfectly at home in the most artfully modern gyms. But it's far more than mere looks. Crafted from thick steel plate and gray panels that can be customized with the most detailed logo and any Pantone color, this Rack comes features PU saddles that cradle round-head dumbbells from 1-10kg in size and is made to withstand the intense rigors of the high-traffic commercial gyms. When users are at their most tired, slamming weights back into place, this Rack guarantees the safety of the surroundings, the dumbbells, and the users. Its economical use of floor space means it fits most anywhere but with its fashionable profile you may want it front and center.



Order Code
ZEX-DBVS-7313

Item Description
EX 1 - 10kg Vertical Studio Dumbbell Rack 2.0

| | | |
|-----------------------|---|---|
| Description |  | EX 1 - 10kg Vertical Studio Dumbbell Rack 2.0 |
| Specifications |  | Made with thick plate welded steel reinforced frame, branded boards front and back with chrome-colored hardware and PU saddles |
| Product Color |  |  Metallic black powder-coated finish with black panels |
| Storage |  | Fits 10-pairs of round-head dumbbells |
| Dimensions |  | 71cm x 163cm x 42cm - 60kg |
| Warranty |  | Limited 10 year warranty on frames and welding, 1 year on saddles |



EX FUNCTIONAL WALL STORAGE 120

The ZIVA® EX Wall Storage 120 offers commercial gyms an expanded storage solution that makes the most out of floorspace while serving as a functional display case and delivering a premium aesthetic. Crafted with heavy-duty steel tubing, and thick plate steel with reinforced welds across its frame, its 5x PVC-lined shelves bring twice as much storage space as its little brother and allow for storage and display of balls, bags, and bells as needed.



Order Code
ZEX-XWMT-5295

Item Description
EX Functional Wall Storage 120

| | | |
|-----------------------|--|--|
| Description | | EX Functional Wall Storage 120 |
| Specifications | | Made with steel tubing, thick plate steel, welded frames, black with grey-colored hardware |
| Product Color | | Black & grey powder-coated finish |
| Storage | | Fits wall balls, medicine balls, power core bags, slam balls, and dumbbells |
| Dimensions | | 120cm x 20cm x 190cm - 121kg |
| Warranty | | Limited 10 year warranty on frames and welding, 1 year on plastic parts |

ST 10-PAIR X-BRACE DUMBBELL RACK

The ZIVA® ST 10-Pair X-Brace Dumbbell Rack features our unique design and superior materials and craftsmanship, and perfectly nestles dumbbells in individual PVC cradles so as to immediately display their weights, and make them easily racked and unracked. The rack's feet come covered in a floor-protecting rubber covering and its X-Brace design give it maximum stability despite its minimalist look.



Order Code
ZST-DBXB-5397

Item Description
ST 10 Pair X-Brace Dumbbell Rack

| | | |
|-----------------------|--|--|
| Description | | ST 10-Pair X-Brace Dumbbell Rack |
| Specifications | | Horizontal style frame, forward tilted saddles, 3mm thick round tube steel and non-marking feet with option to bolt down |
| Product Color | | Black powder-coated finish |
| Storage | | Fits 10-pairs of round head dumbbells |
| Dimensions | | 226cm x 80.8cm x 66.5cm - 69kg |
| Warranty | | Limited 10 year warranty on frames and welding, 1 year on plastic parts |







ST 5-PAIR HORIZONTAL DUMBBELL RACK

The ZIVA® ST 5-Pair Horizontal Dumbbell Rack features a unique design crafted from thick round steel tubing and curved weight cradles that both store and display. Dumbbells nestle perfectly so as to immediately display their weights, and are easily racked and unracked thanks to the ergonomically forward tilted shelving.



Order Code
ZST-DBST-5392

Item Description
ST 5-Pair Horizontal Dumbbell Rack

| | | |
|-----------------------|---|--|
| Description |  | ST 5-Pair Horizontal Dumbbell Rack |
| Specifications |  | Horizontal style frame, forward tilted saddles, 3mm thick round tube steel and non-marking feet with option to bolt down |
| Product Color |  |  Black powder-coated finish |
| Storage |  | Fits 5-pairs of round head dumbbells |
| Dimensions |  | 116cm x 80.8cm x 66.5cm - 45kg |
| Warranty |  | Limited 10 year warranty on frames and welding, 1 year on plastic parts |







ST 10-PAIR HORIZONTAL DUMBBELL RACK

The ZIVA® ST 10-Pair Horizontal Dumbbell Rack doubles the length and capacity of the 5-Pair Rack but features the same unique design and superior materials and craftsmanship. Dumbbells nestle perfectly so as to immediately display their weights, and are easily racked and unracked thanks to the ergonomically forward tilted shelving.



Order Code
ZST-DBST-5393

Item Description
ST 10-Pair Horizontal Dumbbell Rack

| | | |
|-----------------------|---|--|
| Description |  | ST 10-Pair Horizontal Dumbbell Rack |
| Specifications |  | Horizontal style frame, forward tilted saddles, 3mm thick round tube steel and non-marking feet with option to bolt down |
| Product Color |  |  Black powder-coated finish |
| Storage |  | Fits 10-pairs of round head dumbbells |
| Dimensions |  | 226cm x 80.8cm x 66.5cm - 69kg |
| Warranty |  | Limited 10 year warranty on frames and welding, 1 year on plastic parts |

ST 5-PIECE BARBELL RACK

The ZIVA® ST 5-Piece Barbell Rack features an eye-catching curved design that immediately gives its load and its surroundings a higher-end feel. Crafted with 3mm thick steel tubing and featuring a scratch-, rust-, and wear-resistant black powder coat, this Rack is built to look great for longer despite the busiest, most bustling commercial gym surroundings, and its floor-protecting footpads keep those surroundings looking great, too.



Order Code
ZST-BBRK-5390

Item Description
ST 5-Piece Barbell Rack

| | | |
|-----------------------|--|--|
| Description | | ST 5-Piece Barbell Rack |
| Specifications | | Vertical style frame, 3mm thick round tube steel and non-marking feet with option to bolt down |
| Product Color | | Black powder-coated finish |
| Storage | | Fits 5 barbells or EZ curl bars |
| Dimensions | | 72cm x 132cm x 96.8cm - 37kg |
| Warranty | | Limited 10 year warranty on frames and welding, 1 year on plastic parts |

ST 10-PIECE BARBELL RACK

The ZIVA® ST 10-Piece Barbell Rack features the same eye-catching curved design as the 5-Piece Rack, but doubles the capacity. Crafted with 3mm thick steel tubing and featuring a scratch-, rust-, and wear-resistant black powder coat, this Rack is built to look great for longer despite the busiest, most bustling commercial gym surroundings, and its floor-protecting footpads keep those surroundings looking great, too.



Order Code
ZST-BBRK-5391

Item Description
ST 10-Piece Barbell Rack

| | | |
|-----------------------|--|--|
| Description | | ST 10-Piece Barbell Rack |
| Specifications | | Vertical style frame, 3mm thick round tube steel and non-marking feet with option to bolt down |
| Product Color | | Black powder-coated finish |
| Storage | | Fits 10 barbells or EZ curl bars |
| Dimensions | | 89.4cm x 131.4cm x 96.8cm - 53kg |
| Warranty | | Limited 10 year warranty on frames and welding, 1 year on plastic parts |







ST DISC STORAGE RACK

The ZIVA® ST Disc Storage Rack is built tough with thick steel tubing, scratch-, wear-, and rust-resistant black powder coating, and 6x polished steel storage posts. This Rack keeps high-traffic commercial gyms uncluttered and organized for a higher-end look and feel that makes it easier for users to feel inspired. With its rugged look and ability to hold up to 25kg plates, it's a must-have alongside squat racks, benches, and lifting platforms.



Order Code
ZST-ODRK-5394

Item Description
ST Disc Storage Rack

| | | |
|-----------------------|---|---|
| Description |  | ST Disc Storage Rack |
| Specifications |  | Vertical style frame, holds all ZIVA grip discs. Comes with non-marking feet with option to bolt down and polished steel storage spindles |
| Product Color |  |  Black powder-coated finish |
| Storage |  | Stores up to 25kg Olympic grip discs |
| Dimensions |  | 73.3cm x 110cm x 62cm - 33kg |
| Warranty |  | Limited 10 year warranty on frames and welding, 1 year on plastic parts |

ST 1-10KG STUDIO DUMBBELL RACK

The ZIVA® ST 1-10KG Studio Dumbbell Rack stores every size and variation of smaller dumbbells, and does so with an eye-catching curved design that immediately gives its surroundings a modern, attractive look and feel. The Rack features a black powder coat that is rust- and scratch-resistant; floor-protecting footpads; and PU-cushioned saddles. It is built to be a long-lasting, beautiful display piece with the organizational ability to keep its surroundings beautiful, as well.



Order Code
ZST-VS10-5396

Item Description
ST 1-10kg Studio Dumbbell Rack

| | | |
|-----------------------|--|--|
| Description | | ST 1-10kg Studio Dumbbell Rack |
| Specifications | | Compact vertical dumbbell rack with minimal footprint, PU cushioned saddles, steel saddles and non-marking feet with option to bolt down |
| Color Options | | <input checked="" type="checkbox"/> Black powder-coated finish |
| Storage | | Fits 1-10kg Hexagon Dumbbells, 1-10 Neoprene Tribells, 1-10kg Urethane Tribells, and 1-10kg Urethane Studio Dumbbells |
| Dimensions | | 153.5cm x 92cm x 54cm - 50kg |
| Warranty | | Limited 10 year warranty on frames and welding, 1 year on plastic parts |

ST 20-PAIR 1-10KG STUDIO DUMBBELL RACK

The ZIVA® ST 20-Pair 1-10KG Studio Dumbbell Rack stores an entire class's worth of dumbbells. It can fit every size and variation of smaller dumbbell on its eye-catching curves, giving its surroundings a modern, attractive look and feel. The Rack features a black powder coat that is rust- and scratch-resistant; floor-protecting footpads; and PU-cushioned saddles. It is built to be a long-lasting, beautiful display piece with the organizational ability to keep its surroundings beautiful, too.



Order Code
ZST-DBST-1835

Item Description
ST 20-Pair 1-10kg Studio Dumbbell Rack







| | | |
|-----------------------|--|--|
| Description | | ST 20-Pair 1-10kg Studio Dumbbell Rack |
| Specifications | | Compact vertical dumbbell rack with minimal footprint, PU cushioned saddles, steel saddles and non-marking feet with option to bolt down |
| Color Options | | <input checked="" type="checkbox"/> Black powder-coated finish |
| Storage | | Fits 1-10kg Hexagon Dumbbells, 1-10 Neoprene Tribells, 1-10kg Urethane Tribells, and 1-10kg Urethane Studio Dumbbells |
| Dimensions | | 112cm x 71 cm x 142cm - 77kg |
| Warranty | | Limited 10 year warranty on frames and welding, 1 year on plastic parts |

ST 2-TIER, 10-PAIR HEXAGON DUMBBELL RACK

The ST 2-Tier, 10-Pair Hexagon Dumbbell Rack offers users fast, easy access to the tools they need for any kind of dumbbell work. The Rack's shelves are ergonomically angled for the safest and easiest removal and return, and the entire structure has been designed with an aesthetic made to match ZIVA Hexagon Dumbbells, giving a cohesive and overall higher-end look and feel. Use this Rack to power members' workouts with always fast access to equipment while delivering an elite-level look and intuitive organization.



| Order Code | Item Description |
|---------------|--|
| ZST-DBST-4970 | ST 2-Tier, 10-Pair Hexagon Dumbbell Rack |







| | | |
|-----------------------|---|--|
| Description |  | ST 2-Tier, 10-Pair Hexagon Dumbbell Rack |
| Specifications |  | Horizontal style frame, flat shelving design without saddles, 3mm thick round tube steel and non-marking feet with option to bolt down |
| Color Options |  | <input checked="" type="checkbox"/> Black powder-coated finish |
| Storage |  | Fits 10-pairs of hexagon dumbbells up to 50kg |
| Dimensions |  | 220cm x 81cm x 62cm - 52kg |
| Warranty |  | Limited 10 year warranty on frames and welding, 1 year on plastic parts |

ST2 HEXAGON DUMBBELL RACK

The ZIVA® ST2 Hexagon Dumbbell Rack beautifully stores hexagon dumbbells up to 25kg large on an eye-catching curved design that immediately gives its surroundings an elevated feel. This Rack features a scratch- and rust-proof black powder coat; floor-protecting footpads; and PU-cushioned saddles. It is built to be a long-lasting, beautiful dumbbell organizer but doubles as an exquisite display piece that beautifies the entire gym around it.



| Order Code | Item Description |
|---------------|---------------------------|
| ZST-DBST-4967 | ST2 Hexagon Dumbbell Rack |







| | | |
|-----------------------|---|---|
| Description |  | ST2 Hexagon Dumbbell Rack |
| Specifications |  | Compact vertical style frame, 3mm thick round tube steel and non-marking feet with option to bolt down. |
| Color Options |  | <input checked="" type="checkbox"/> Black powder-coated finish |
| Storage |  | Fits 10-pairs of hexagon dumbbells, 1 - 10kg, 2 - 20kg and 2.5 - 25kg |
| Dimensions |  | 52cm x 68cm x 162cm - 39kg |
| Warranty |  | Limited 10 year warranty on frames and welding, 1 year on plastic parts |

XP 5-PAIR DUMBBELL RACK WITH SADDLES

The ZIVA® XP 5-Pair Dumbbell Rack with Saddles is a no-nonsense storage solution that features hard-wearing 75 x 75mm steel tubing and curved weight cradles that perfectly nestle dumbbells for immediate weight number display. The ergonomically tilted cradles and shelves make racking and unracking easy, fast, and safe.



| Order Code | Item Description |
|---------------|--------------------------------------|
| ZXP-DBST-5909 | XP 5-Pair Dumbbell Rack with Saddles |

| | | |
|-----------------------|---|--|
| Description |  | XP 5-Pair Dumbbell Rack with Saddles |
| Specifications |  | Made with 75mm x 75mm tubing, horizontal style frame, forward tilted saddles and non-marking feet with option to bolt down |
| Product Color |  | <input checked="" type="checkbox"/> Black powder-coated finish |
| Storage |  | Fits 5-pairs of round head dumbbells |
| Dimensions |  | 120cm x 66.8cm x 86.7cm - 48kg |
| Warranty |  | Limited 10 year warranty on frames and welding, 1 year on plastic parts |

XP 8-PAIR DUMBBELL RACK WITH SADDLES

The ZIVA® XP 8-Pair Dumbbell Rack with Saddles expands on the 5-Pair Rack and features the same no-nonsense, hard-wearing 75 x 75mm steel tubing and curved weight cradles that perfectly nestle dumbbells for immediate weight number display, and are easily racked and unracked with ergonomically forward tilted shelving.



Order Code
ZXP-DBST-3999

Item Description
XP 8-Pair Dumbbell Rack with Saddles

| | | |
|-----------------------|--|--|
| Description | | XP 8-Pair Dumbbell Rack with Saddles |
| Specifications | | Made with 75mm x 75mm tubing, horizontal style frame, forward tilted saddles and non-marking feet with option to bolt down |
| Product Color | | Black powder-coated finish |
| Storage | | Fits 8-pairs of round head dumbbells |
| Dimensions | | 190cm x 66.8cm x 86.7cm - 62kg |
| Warranty | | Limited 10 year warranty on frames and welding, 1 year on plastic parts |

XP 10-PAIR DUMBBELL RACK WITH SADDLES

The ZIVA® XP 10-Pair Dumbbell Rack with Saddles expands on the 5- and 8-Pair Racks and features the same no-nonsense, hard-wearing 75 x 75mm steel tubing and curved weight cradles that perfectly nestle dumbbells to display their weights, and are easily racked and unracked thanks to the ergonomically forward tilted shelving.



Order Code
ZXP-DBST-5908

Item Description
XP 10-Pair Dumbbell Rack with Saddles







| | | |
|-----------------------|--|--|
| Description | | XP 10-Pair Dumbbell Rack with Saddles |
| Specifications | | Made with 75mm x 75mm tubing, horizontal style frame, forward tilted saddles and non-marking feet with option to bolt down |
| Product Color | | Black powder-coated finish |
| Storage | | Fits 10-pairs of round-head dumbbells |
| Dimensions | | 240cm x 66.8cm x 86.7cm - 70kg |
| Warranty | | Limited 10 year warranty on frames and welding, 1 year on plastic parts |

XP 10-PAIR, 3-TIER DUMBBELL RACK WITH SADDLES

The ZIVA® XP 10-Pair, 3-Tier Dumbbell Rack with Saddles takes all the storage of the 10-Pair Rack and packs it into a tighter frame with a smaller footprint. This Rack features the same no-nonsense, hard-wearing 75 x 75mm steel tubing and curved weight cradles that perfectly nestle dumbbells to display their weights, and are easily racked and unracked thanks to the ergonomically forward tilted shelving.



| Order Code | Item Description |
|---------------|---|
| ZXP-DBST-2331 | XP 10-Pair, 3-Tier Dumbbell Rack with Saddles |

| | |
|-----------------------|--|
| Description |  XP 10-Pair, 3-Tier Dumbbell Rack with Saddles |
| Specifications |  Made with 75mm x 75mm tubing, horizontal style frame, forward tilted saddles and non-marking feet with option to bolt down |
| Product Color |   Black powder-coated finish |
| Storage |  Fits 10-pairs of round-head dumbbells |
| Dimensions |  213 x 96 x 114cm - 115kg |
| Warranty |  Limited 10 year warranty on frames and welding, 1 year on plastic parts |





24
LINA

20
LINA

16
LINA

12
LINA

XP 5-PIECE BARBELL RACK

The ZIVA® XP 5-Piece Barbell Rack is a no-nonsense barbell and EZ bar storage station. This Barbell Rack uses tough-built 75 x 75mm steel tubing with a scratch-resistant black powder coating and glass-filled nylon saddles attached with chromed hardware. This piece is built to last and stay looking great in even the busiest commercial gyms.



Order Code
ZXP-BBRK-3625

Item Description
XP 5-Piece Barbell Rack

| | | |
|-----------------------|--|---|
| Description | | XP 5-Piece Barbell Rack |
| Specifications | | Made with 75mm x 75mm tubing, vertical style frame, hard-wearing glass filled nylon saddles and non-marking feet with option to bolt down |
| Product Color | | Black powder-coated finish |
| Storage | | Fits 5 barbells or EZ curl bars |
| Dimensions | | 96.5 cm x 68.6 cm x 119.4 cm - 37kg |
| Warranty | | Limited 10 year warranty on frames and welding, 1 year on plastic parts |

XP BARBELL RACK

The ZIVA® XP Barbell Rack doubles the storage space of the 5-Piece Rack with this no-nonsense barbell and EZ bar storage station. This Barbell Rack uses tough-built 75 x 75mm steel tubing with a scratch-resistant black powder coating and glass-filled nylon saddles attached with chromed hardware. This piece is built to last and stay looking great in even the busiest commercial gyms.



Order Code
ZXP-BBRK-4699

Item Description
XP Barbell Rack

| | | |
|-----------------------|--|---|
| Description | | XP Barbell Rack |
| Specifications | | Made with 75mm x 75mm tubing, vertical style frame, hard-wearing glass filled nylon saddles and non-marking feet with option to bolt down |
| Product Color | | Black powder-coated finish |
| Storage | | Fits 10 barbells or EZ curl bars |
| Dimensions | | 71cm x 60cm x 159cm - 41kg |
| Warranty | | Limited 10 year warranty on frames and welding, 1 year on plastic parts |



XP PLATE TREE (18 PIECES)

The ZIVA® XP Plate Tree is a no-nonsense storage solution that can hold weight plates up to 25kg in size on its 6x polished steel storage posts. It can be further loaded with 2x Olympic bars in its steel tube holsters. Crafted from thick steel tubing with a scratch-, wear, and rust-resistant black powder coating, this Rack keeps high-traffic commercial gyms uncluttered and organized. It's a rugged must-have alongside squat racks, benches, and lifting platforms where its load is needed most.



Order Code
ZXP-ODRK-4015

Item Description
XP Plate Tree (18 pieces)

| | | |
|-----------------------|---|--|
| Description |  | XP Plate Tree (18 pieces) |
| Specifications |  | Made with 75mm x 75mm tubing, vertical plate tree able to hold all ZIVA grip discs designs |
| Product Color |  |  Black powder-coated finish |
| Storage |  | Stores up to 25kg Olympic discs |
| Dimensions |  | 71cm x 67cm x 135cm - 34kg |
| Warranty |  | Limited 10 year warranty on frames and welding, 1 year on plastic parts |







XP STORAGE BOX

The ZIVA® XP Storage Box, built completely from steel with a scratch- and wear-resistant black powder-coating to withstand the rigors of high-traffic commercial gyms, makes it easy to keep all gym areas clutter-free so a premium look and feel is constantly maintained. Large enough to fit all of an area's accessory equipment, the Storage Box comes with 4x 360° wheels so moving whatever is needed wherever it's needed is always simple and fast.



Order Code
ZXP-SBXW-1198

Item Description
XP Storage Box

| | | |
|-----------------------|---|--|
| Description |  | XP Storage Box |
| Specifications |  | A lockable all-steel storage box on wheels for storing all of those small accessories |
| Color Options |  |  Black powder-coated finish |
| Dimensions |  | 60cm x 50cm x 85cm - 60kg |
| Warranty |  | Limited 10 year warranty on frames and welding, 1 year on plastic parts |



XP MODULAR STORAGE RACK

The XP Modular Storage Rack System is the gold standard for storage. Built from steel tubing and thick plate steel, it holds anything and everything. From plates to dumbbells, kettlebells, bags, and balls of every size, this Storage Rack System keeps all manner of gym equipment on hand and perfectly organized. Even usually cumbersome balls are kept perfectly in place thanks to its specially designed steel tube shelving. But its most amazing feature is its customizability. If your facility has more equipment than a single set of shelving can handle, this modular system is simple and easy to expand, and saves space versus two separate storage solutions.



| | | |
|-----------------------|--|--|
| Description | | XP Modular Storage Rack System |
| Specifications | | Made with 75 x 75mm steel tubing 3mm thick, thick plate steel, welded frames, and black-colored hardware |
| Product Color | | Black powder-coated finish |
| Storage | | Fits all ZIVA accessories |
| Dimensions | | ZXP-SFRK-6959 - 232cm x 114cm x 211cm - 162kg ZXP-SFRK-6961 - 209cm x 114cm x 211cm - 133kg |
| Warranty | | Limited 10 year warranty on frames and welding, 1 year on plastic parts |



| Order Code | Item Description | Order Code | Item Description |
|---------------|---|---------------|---|
| ZXP-SFRK-6959 | 1 XP Modular Storage Rack Standard Anchor Bay - 2m Width | ZXP-SFRK-0212 | 8 XP Modular Storage Rack Extension Upright |
| ZXP-SFRK-6961 | 2 XP Modular Storage Rack Extended Add-a-Bay - 2m Width | ZXP-SFRK-0213 | 9 Top - Rails for Stability Balls - 2m Width |
| ZXP-SFRK-6960 | 3 XP Modular Storage Rack Standard Add-a-Bay - 1.5m Width | ZXP-SFRK-0214 | 10 2nd - Rails for Large Medicine Balls (14\"/> |

ROSC



65
ZIVA

65
ZIVA

65
ZIVA

02
ZIVA

04
ZIVA

06
ZIVA

08
ZIVA

10
ZIVA

10
ZIVA

15
ZIVA

10
ZIVA

12
ZIVA

14
ZIVA

16
ZIVA

8
ZIVA

10
ZIVA

12
ZIVA

14
ZIVA

16
ZIVA

18
ZIVA

20
ZIVA

ZIVA
5
VAIZ

ZIVA
5
VAIZ

ZIVA
10
VAIZ

ZIVA
15
VAIZ

ZIVA
20
VAIZ

ZIVA
20
VAIZ

XP 4-TIER STORAGE RACK

The ZIVA® XP 4-Tier Storage Rack is a storage and display piece that holds balls, dumbbells, functional fitness equipment, and kettlebells of most sizes and features swiveling wheels for quick, easy movement around the gym. Crafted from thick steel tubing & plate steel with a scratch-, rust-, and corrosion-resistant powder coat, this 4-tier Rack is ideal for personal trainers who need to move rapidly from one workout and one client to the next.



| Order Code | Item Description |
|---------------|--|
| ZXP-TBSR-6775 | XP 4-Tier Storage Rack |
| ZXP-TBSR-4491 | XP Training Toolkit Set |
| ZXP-TBSR-4071 | XP 4-Tier Storage Rack + XP Training Toolkit Set |







| | | |
|-----------------------|---|--|
| Description |  | XP 4-Tier Storage Rack |
| Specifications |  | Horizontal style frame, 3mm thick oval tube steel and wheeled base for easy portability |
| Product Color |  |  Black powder-coated finish |
| Dimensions |  | 166cm x 84cm x 166cm - 110kg |
| Warranty |  | Limited 10 year warranty on frames and welding; 1 year on plastic parts |

XP 4-SHELF MULTI-FUNCTIONAL STORAGE RACK 2.0

The XP 4-Shelf Multi-Functional Storage Rack 2.0 delivers the same beauty and practicality as its predecessor with a few updates. The 2.0 brings 2x levels dedicated to ball storage - with perfectly spaced railings that make sure balls stay stable - and 2x levels of universal storage that fit anything from dumbbells to kettlebells to weight plates. It brings the same great solution for a clean, organized, and safely uncluttered workout area as well as a slightly updated aesthetic.



| Order Code | Item Description |
|---------------|--|
| ZXP-MFSR-7219 | XP 4-Shelf Multi-Functional Storage Rack 2.0 |

| | | |
|-----------------------|---|--|
| Description |  | XP 4-Shelf Multi-Functional Storage Rack 2.0 |
| Specifications |  | 3mm thick steel, multi-storage rack stores on top two shelves wall balls, med balls, and slam balls only with bottom two shelves storing hex dumbbells, kettlebells, or bumper discs |
| Product Color |  |  Black powder-coated finish |
| Dimensions |  | 187cm x 86cm x 182cm - 120kg |
| Warranty |  | Limited 10 year warranty on frames and welding; 1 year on plastic parts |

BUMPERS AND OLYMPIC BARS

Both timely and timeless, the drive to be stronger, lift more, and reach higher is fueled by the exceptional bumpers and bars found here and catering to the growing population of strength-focused users.



Our selection of bumpers and bars deliver commercial quality made to meet the needs of today's Olympic lifters, powerlifters, and heavy strength users. Heavy deadlifts and squats, drops from Olympic heights, and bar-bending, PR-smashing loads are the order of business when choosing this equipment.

The ZVO bars and bumpers found in this section are the pinnacle of performance and quality with second-to-none design, materials, and construction made especially for gyms looking for the best of the best.

The SL Series of bumpers brings attractive mid-range style and terrific, long-lasting performance.

XP2 bumpers bring no-nonsense, no frills, and always great commercial quality to Olympic lifters looking for an economical solution.

All these choices offer what are today essentials for any gym hoping to attract dedicated strength users who will undoubtedly become gyms' greatest evangelists. Every bar and bumper here has been designed so lifters can achieve new highs of performance that will make them loyal to the facility that helped them get there.

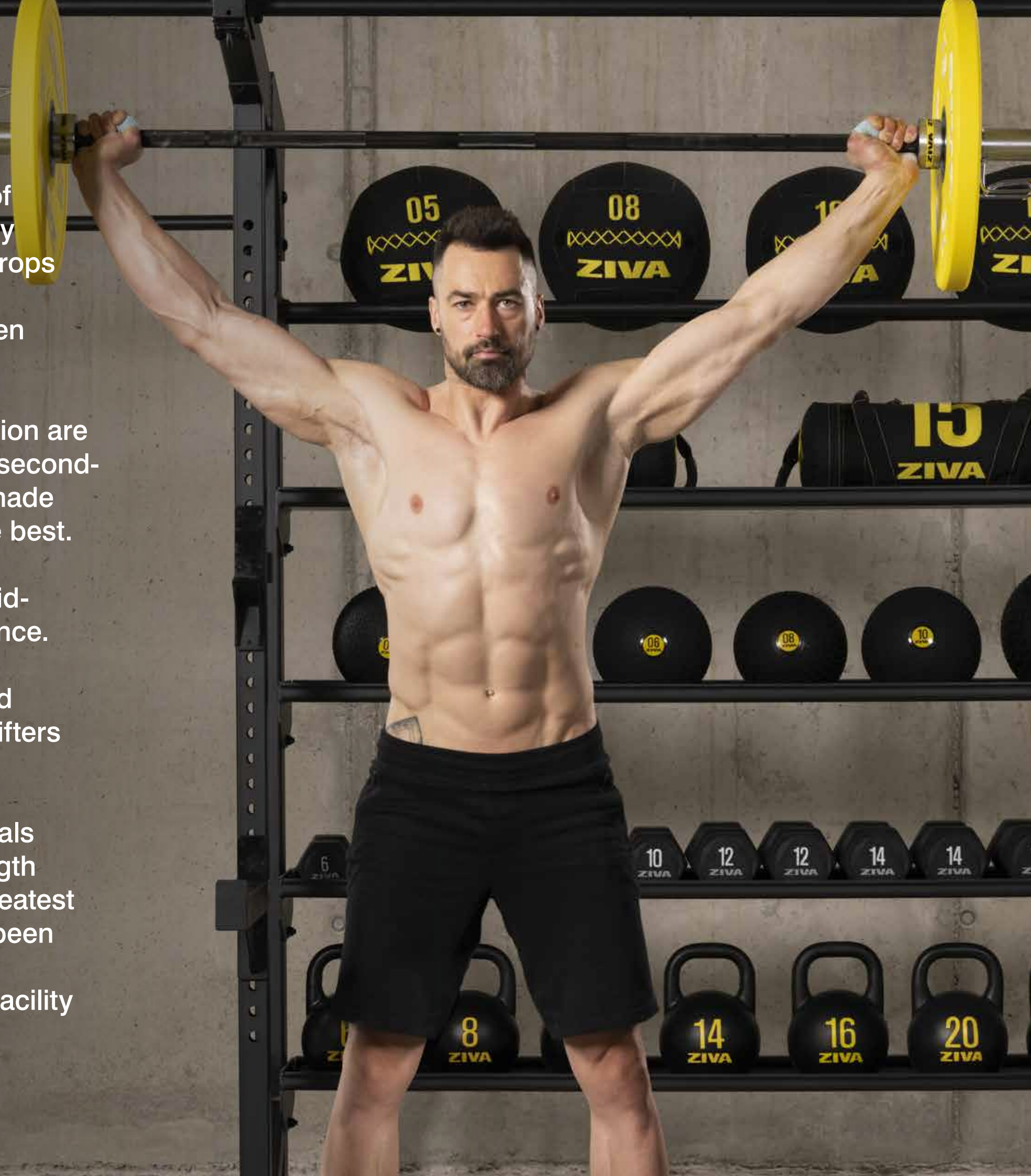



“

ZIVA offers Lift Brands a solution by ensuring access to a large range of products that our franchises love. The product and price is one of the best in the business but the extra attention, care factor and willing to truly be a partner and not just a vendor is what makes ZIVA a great company to do business with.

Andy Peat

Chief Product Officer

”

snap 24/7
fitness

BUMPER PLATES

PREMIUM



Use: Strength training areas for elite training or competition and super high usage

Coat Material: Urethane or premium rubber

Central Insert: Large, hard chrome plated hubs

Customer: Big club chains, premium gyms, and top hotels

Warranty: 5 years on urethane, 3 years on rubber

MID-RANGE



Use: Strength training areas for heavy training and heavy use

Coat Material: Urethane or rubber

Central Insert: Large, chrome plated hubs

Customer: Club chains, mid-market gyms and studios

Warranty: 4 years on urethane, 2 years on rubber

ENTRY



Use: Strength training areas for mid-to-heavy training and lighter use

Coat Material: Rubber

Central Insert: Large, chrome plated hubs

Customer: Club chains, mid-market gyms and studios

Warranty: 1 year

ZVO URETHANE COMPETITION COLORED BUMPER DISCS

5 YEAR WARRANTY



Molded numbers



Large hard chrome plated hubs with internal diameter of 50.3mm



Beveled edges for easy pickup



International standard 450mm outer diameter



Elite urethane coating



Competition colour coding

ZVO URETHANE COMPETITION COLORED BUMPER DISCS

ZIVA® ZVO Urethane Competition Colored Bumper Discs are the toughest, most well-built, most thoughtfully designed competition bumper plates in the world. Precision cast in vibrant IWF-standard colors, these bumper discs feature hard chrome-plated hubs and an ultra-long-lasting urethane coat that holds color for longer than anything else in its class. Built to withstand the intensity of Olympic competition and repeated drops from Olympic heights, their competition colors make them immediately recognizable while their beveled edges make for fast and easy loading and unloading from the bar.



| Order Code | Item Description |
|------------------|--|
| ZVO-BDPU-3702-BK | ZVO Urethane Competition Colored Bumper Disc 5kg (80mm Hard Chrome Hub) |
| ZVO-BDPU-3703-GN | ZVO Urethane Competition Colored Bumper Disc 10kg (120mm Hard Chrome Hub) |
| ZVO-BDPU-3704-YL | ZVO Urethane Competition Colored Bumper Disc 15kg (120mm Hard Chrome Hub) |
| ZVO-BDPU-3705-BL | ZVO Urethane Competition Colored Bumper Disc 20kg (120mm Hard Chrome Hub) |
| ZVO-BDPU-3706-RD | ZVO Urethane Competition Colored Bumper Disc 25kg (120mm Hard Chrome Hub) |
| ZVO-BDPU-3700 | ZVO Urethane Fractional Disc Set (2x0.5kg, 2x1kg, 2x1.5kg, 2x2kg, 2x2.5kg) |

| | | |
|----------------------|--|--|
| Description | | ZVO Urethane Competition Colored Bumper Disc |
| Coating | | Ultra-premium urethane surface coating |
| Color Options | | Black / White Green / White Yellow / White Blue / White Red / White |
| Increments | | 5kg increments |
| Warranty | | Limited 5 year warranty |

ZVO RUBBER COMPETITION COLORED TRAINING BUMPER DISCS

ZIVA® ZVO Rubber Competition Colored Training Bumper Discs are extremely well-built, thoughtfully designed bumper plates that deliver the satisfying bounce of rubber. Precision cast in vibrant IWF-standard colors, these bumper discs feature hard chrome-plated hubs that help them slide more quickly and easily on and off the bar. Built for repeated drops from Olympic heights, their beveled edges make for easier pick up so training is faster and easier.



| Order Code | Item Description |
|------------------|--|
| ZVO-BDRB-3711-BK | ZVO Rubber Competition Colored Training Bumper Disc 5kg (80mm Hard Chrome Hub) |
| ZVO-BDRB-3712-GN | ZVO Rubber Competition Colored Training Bumper Disc 10kg (120mm Hard Chrome Hub) |
| ZVO-BDRB-3713-YL | ZVO Rubber Competition Colored Training Bumper Disc 15kg (120mm Hard Chrome Hub) |
| ZVO-BDRB-3714-BL | ZVO Rubber Competition Colored Training Bumper Disc 20kg (120mm Hard Chrome Hub) |
| ZVO-BDRB-3715-RD | ZVO Rubber Competition Colored Training Bumper Disc 25kg (120mm Hard Chrome Hub) |
| ZVO-BDRB-3709 | ZVO Rubber Fractional Disc Set (2x0.5kg, 2x1kg, 2x1.5kg, 2x2kg, 2x2.5kg) |

| | | |
|----------------------|--|--|
| Description | | ZVO Rubber Competition Colored Training Bumper Disc |
| Coating | | Premium solid virgin rubber |
| Color Options | | Black / White Green / White Yellow / White Blue / White Red / White |
| Increments | | 5kg increments |
| Warranty | | Limited 3 year warranty |

SL BLACK URETHANE COMPETITION BUMPER DISCS

The SL Urethane Black Bumper Disc is made tough to absorb the repeated shock of drops from height that come with Olympic training. They use high durability urethane coats to deliver long-lasting protection, and are crafted with beveled edges for easy pick up. The discs' hub inserts are made from scratch- and rust-resistant chrome that improve their ability to slide on and off the bar, so pace of training can stay consistently high energy and high intensity.



| Order Code | Item Description |
|---------------|--|
| ZSL-BDPU-3555 | SL Black Urethane Competition Bumper Disc With Chrome Hub 5kg |
| ZSL-BDPU-3556 | SL Black Urethane Competition Bumper Disc With Chrome Hub 10kg |
| ZSL-BDPU-3557 | SL Black Urethane Competition Bumper Disc With Chrome Hub 15kg |
| ZSL-BDPU-3558 | SL Black Urethane Competition Bumper Disc With Chrome Hub 20kg |
| ZSL-BDPU-3559 | SL Black Urethane Competition Bumper Disc With Chrome Hub 25kg |

| | | |
|----------------------|--|---|
| Description | | SL Black Urethane Competition Bumper Disc |
| Coating | | Ultra-premium urethane surface coating |
| Color Options | | Black / White Black / Green Black / Yellow Black / Blue Black / Red |
| Increments | | 5kg increments |
| Warranty | | Limited 4 year warranty |



SL RUBBER COMPETITION COLORED BUMPER DISCS

2 YEAR WARRANTY



Screen printed numbers

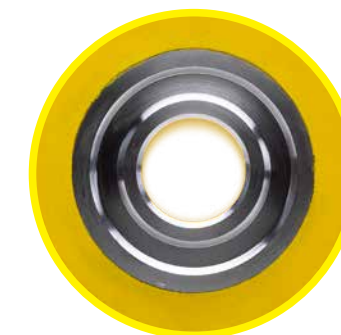

Large chrome plated hubs with
internal diameter of 50.3mm



Beveled edges
for easy pickup



International standard
450mm outer diameter



Premium rubber coating



Competition colour coding

SL RUBBER COMPETITION COLORED TRAINING BUMPER DISCS

The ZIVA SL Rubber Competition Colored Training Bumper Disc is made with premium rubber to absorb the shock of Olympic competition while providing floor protection and superior performance. Their hard-wearing, shock absorbent rubber coats make them perfect for increasingly popular Olympic lifts because even when dropped from an overhead position, they resist cracks and deformation. These premium weight discs are crafted with beveled edges for easy pick up and come with a large scratch- and rust-resistant chrome-plated internal hub that allows for smoother loading and unloading as well as rotation on the bar. In vibrant standard IWF competition colors, these discs are as close to competition day as you can get.



| Order Code | Item Description |
|------------------|---|
| ZSL-BDRB-9051-BK | SL Rubber Competition Colored Training Bumper Disc 5kg |
| ZSL-BDRB-9052-GN | SL Rubber Competition Colored Training Bumper Disc 10kg |
| ZSL-BDRB-9053-YL | SL Rubber Competition Colored Training Bumper Disc 15kg |
| ZSL-BDRB-9054-BL | SL Rubber Competition Colored Training Bumper Disc 20kg |
| ZSL-BDRB-9055-RD | SL Rubber Competition Colored Training Bumper Disc 25kg |

| | | |
|----------------------|--|--|
| Description | | SL Rubber Competition Colored Training Bumper Disc |
| Coating | | Rubber surface coating |
| Color Options | | Black / White Green / White Yellow / White Blue / White Red / White |
| Increments | | 5kg increments |
| Warranty | | Limited 2 year warranty |

SL RUBBER COMPETITION BLACK TRAINING BUMPER DISCS

The ZIVA® SL Rubber Competition Black Training Bumper Disc is made with premium rubber to absorb the shock of Olympic competition while providing floor protection and superior performance. Their hard-wearing, shock absorbent rubber coats make them perfect for increasingly popular Olympic lifts because even when dropped from an overhead position, they resist cracks and deformation. These premium weight discs are crafted with beveled edges for easy pick up and come with a large scratch- and rust-resistant chrome-plated internal hub that allows for smoother loading and unloading as well as rotation on the bar. With vibrant standard IWF competition colored lettering, training with these discs is training to win.



| Order Code | Item Description |
|---------------|---|
| ZSL-BDRB-1406 | SL Rubber Competition Black Training Bumper Disc 5kg |
| ZSL-BDRB-1407 | SL Rubber Competition Black Training Bumper Disc 10kg |
| ZSL-BDRB-1408 | SL Rubber Competition Black Training Bumper Disc 15kg |
| ZSL-BDRB-1409 | SL Rubber Competition Black Training Bumper Disc 20kg |
| ZSL-BDRB-1410 | SL Rubber Competition Black Training Bumper Disc 25kg |

| | | |
|----------------------|--|--|
| Description | | SL Rubber Competition Black Training Bumper Disc |
| Coating | | Rubber surface coating |
| Color Options | | Black / White Black / Green Black / Yellow Black / Blue Black / Red |
| Increments | | 5kg increments |
| Warranty | | Limited 2 year warranty |

XP2 RUBBER BLACK BUMPER DISCS

1 YEAR WARRANTY



Molded numbers



Large chrome plated hubs with
internal diameter of 50.3mm



Beveled edges
for easy pickup



International standard
450mm outer diameter



Robust rubber coating



Grey and white colours

XP2 RUBBER BLACK BUMPER DISC

ZIVA® XP2 Rubber Black Bumper Discs are no-frills Olympic training discs. They feature impact absorbing, tough rubber that provides great protection for floors and slightly deadens noise. Their stark white numbering stands out crystal clear against the black backdrop of their body, allowing quick ID, and their beveled edges make them easy to pick up, load, and unload. A wide chrome-coated central hub allows effortless sliding on and off the bar and smooth rotation throughout every lift.



| Order Code | Item Description |
|---------------|---|
| ZXP-BPRB-0539 | XP2 Rubber Black Bumper Disc with Chrome Hub 5kg |
| ZXP-BPRB-0540 | XP2 Rubber Black Bumper Disc with Chrome Hub 10kg |
| ZXP-BPRB-0541 | XP2 Rubber Black Bumper Disc with Chrome Hub 15kg |
| ZXP-BPRB-0542 | XP2 Rubber Black Bumper Disc with Chrome Hub 20kg |
| ZXP-BPRB-0543 | XP2 Rubber Black Bumper Disc with Chrome Hub 25kg |

| | | |
|----------------------|---|--|
| Description |  | XP2 Rubber Black Bumper Disc |
| Coating |  | Robust rubber coating |
| Color Options |  |  Black / Grey / White |
| Increments |  | 5kg increments |
| Warranty |  | Limited 1 year warranty |

XP BUMPER STORAGE RACK

The ZIVA® XP Bumper Storage Rack makes moving weight plates as easy as taking a walk. Crafted from 3mm thick commercial-grade steel tube with a scratch-, wear-, and rust-resistant black powder-coated finish, this easily movable rack has wheels at one end and a handle at the other and keeps bumpers well organized for quick, easy use and a premium look. The Bumper Storage rack can store plates from 5-25kg in size, so it fits an entire workout's worth of weight that can be moved around the gym.



ZXP-RGRK-0902 XP Bumper Storage Rack

| | | |
|-----------------------|---|--|
| Description |  | XP Bumper Storage Rack |
| Specifications |  | Made with commercial-grade 3mm thick steel and built-in handle and wheels for easy portability |
| Color Options |  |  Black powder-coated finish |
| Dimensions |  | 118cm x 40cm - 12kg |
| Warranty |  | Limited 10 year warranty on frames and welding, 1 year on plastic parts |







XP FARMERS WALK HANDLES

ZIVA® XP Farmer's Walk Handles take a traditional functional fitness exercise for training grip, core, and traps, and incorporates the heavy-duty ability to add up to 250kg. Made from 3mm thick steel and coated with a scratch- and wear-resistant black powder finish, the Handles help round out a functional fitness area's power-building equipment and tells visitors that this is a gym that prides itself on offering the latest and greatest fitness tools.



Order Code
ZXP-RGRK-0916

Item Description
XP Farmers Walk Handles

| | | |
|-----------------------|---|---|
| Description |  | XP Farmers Walk Handles |
| Specifications |  | 32mm grip diameter and 3mm thick steel |
| Product Color |  |  Charcoal powder-coated finish |
| Dimensions |  | Length 180cm - 24kg per pair |
| Warranty |  | Limited 10 year warranty on frames and welding, 1 year on plastic parts |

OLYMPIC 2.2M BARS

PREMIUM



Use: World-class strength training areas for elite lifters

Bar Diameter: 28mm

Tested To: 900kg

Customer: Big club chains, premium gyms, and top hotels

Warranty: Limited lifetime

MID-RANGE



Use: Strength training areas for intermediate-to-advanced lifters

Bar Diameter: 32mm

Tested To: 680kg

Customer: Club chains, mid-market gyms and studios

Warranty: Limited lifetime

ENTRY

PERFORMANCE

Use: Free weight training areas for beginner-to-intermediate lifters

Bar Diameter: 30mm

Tested To: 450kg

Customer: No-frills option for any facility with a tight budget

Warranty: Limited 1 year

ZVO OLYMPIC BARS

LIMITED LIFETIME WARRANTY

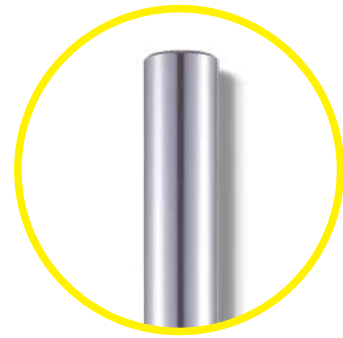

Fits standard Olympic discs



2.2m long, 20kg



Limited lifetime warranty

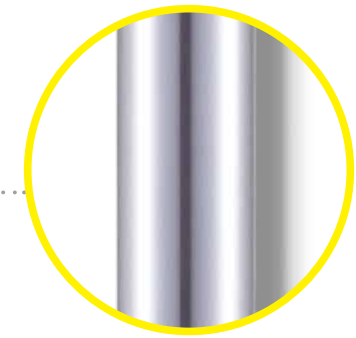

Premium hard coated chrome



Needle bearings and brass bushings for smooth rotation

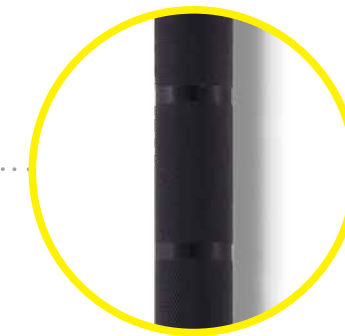

Weight lifting & power lifting grip indicators











ZVO OLYMPIC BARS

ZVO Olympic Bars are the gold standard for weight lifting and strength building. Rated to as much as 900kg with 8x needle bearings nestled inside the premium chrome plated sleeves for super-smooth rotation, these bars are made to meet Olympic level training requirements for world's best lifters, Crossfitters, bodybuilders, strongmen, and other elite athletes. Etched with grip-assisting knurling, these Olympic Bars are an steel-clad testament to a gym's commitment to its members improvement.



| Order Code | Item Description |
|------------------|--|
| ZVO-HCOB-2989 | ZVO Men's 1.7m Technical Bar, 450kg Tested - 25mm, Weight: 10kg |
| ZVO-HCOB-2991 | ZVO Premium Women's 2.01m Olympic Bar, 680kg Tested - 25mm, Weight: 15kg |
| ZVO-HCOB-2990 | ZVO Elite 2.2m Olympic Bar, 900kg Tested - 28mm, Weight: 20kg |
| ZVO-HCOB-3025 | ZVO Premium 2.2m Olympic Bar, 680kg Tested - 32mm, Weight: 20kg |
| ZVO-CFBR-TA57-BK | ZVO Premium 2.2m Olympic Bar, 680kg Tested - 28mm - Weight: 20kg |





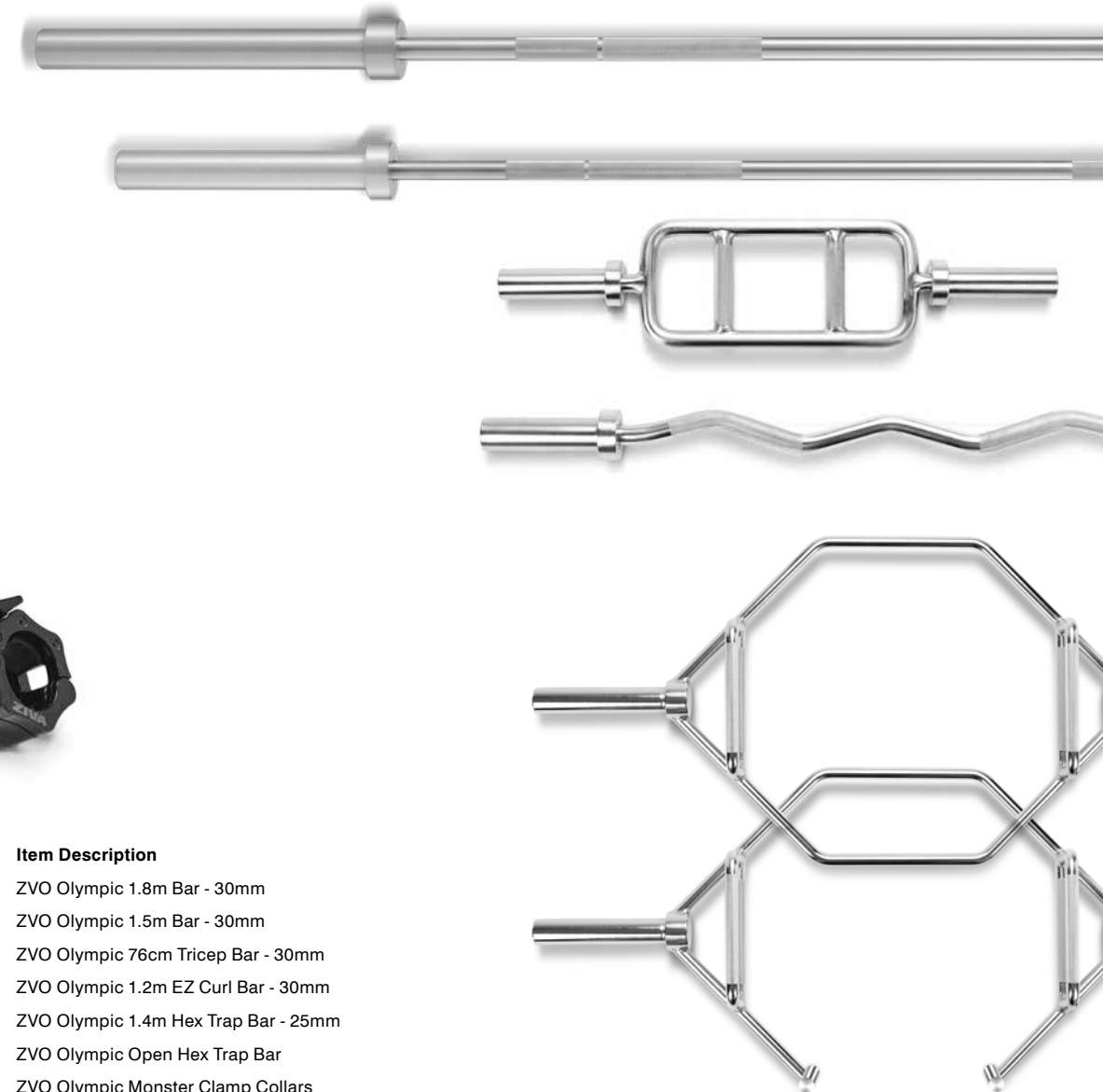

| | | |
|-----------------------|---|--|
| Description |  | ZVO Olympic Bars |
| Coating |  | Premium hard chrome coated 50mm sleeves |
| Handle |  | Knurled grips with needle bearings for smooth and even rotation |
| Color Options |  | <input checked="" type="checkbox"/> Black oxide <input type="checkbox"/> Hard chrome |
| Weight Loading |  | Check the listings below for weight limits |
| Warranty |  | Limited lifetime warranty |

ZVO OLYMPIC BARS

ZVO Olympic Bars come in a variety of shapes and sizes, each specially suited to different exercises that target different muscle groups yet each versatile enough to be used in a broad range of ways. Though they are all different, they share the same exceptional pedigree of superior materials and manufacturing, making them best-in-class by a wide margin.



| Order Code | Item Description |
|------------------|--------------------------------------|
| ZVO-LBHC-2953 | ZVO Olympic 1.8m Bar - 30mm |
| ZVO-LBHC-2954-SV | ZVO Olympic 1.5m Bar - 30mm |
| ZVO-HCOB-2965 | ZVO Olympic 76cm Tricep Bar - 30mm |
| ZVO-HCOB-2966 | ZVO Olympic 1.2m EZ Curl Bar - 30mm |
| ZVO-PBHC-2936 | ZVO Olympic 1.4m Hex Trap Bar - 25mm |
| ZVO-PBHC-1300 | ZVO Olympic Open Hex Trap Bar |
| ZXP-OBCC-0436-BK | ZVO Olympic Monster Clamp Collars |

| | | |
|-----------------------|---|--|
| Description |  | ZVO Olympic Bars |
| Coating |  | Premium urethane surface coating |
| Handle |  | Knurled grips with bearings for smooth and even rotation |
| Color Options |  | <input type="checkbox"/> Chrome |
| Weight Loading |  | Check the listings below for weight limits |
| Warranty |  | Limited lifetime warranty |



| | |
|-------------------------|-------------------------------------|
| Order Code | ZVO-HCOB-2989 |
| Item Description | ZVO Men's 1.7m Technical Bar |
| Weight | 10kg |
| Capacity | 455kg |
| Bar Diameter | 25mm |
| Length | 1.7m |
| Sleeve Length | 50mm diameter; 170mm long |



| | |
|-------------------------|--|
| Order Code | ZVO-HCOB-2991 |
| Item Description | ZVO Premium Women's 2.01m Olympic Bar |
| Weight | 15kg |
| Capacity | 680kg |
| Bar Diameter | 25mm |
| Length | 2.01m |
| Sleeve Length | 50mm diameter; 312mm long |



| | |
|-------------------------|-----------------------------------|
| Order Code | ZVO-HCOB-2990 |
| Item Description | ZVO Elite 2.2m Olympic Bar |
| Weight | 20kg |
| Capacity | 907kg |
| Bar Diameter | 28mm |
| Length | 2.2m |
| Sleeve Length | 50mm diameter; 407mm long |



| | |
|-------------------------|-------------------------------------|
| Order Code | ZVO-HCOB-3025 |
| Item Description | ZVO Premium 2.2m Olympic Bar |
| Weight | 20kg |
| Capacity | 680kg |
| Bar Diameter | 32mm |
| Length | 2.2m |
| Sleeve Length | 50mm diameter; 407mm long |



| | |
|-------------------------|-------------------------------------|
| Order Code | ZVO-CFBR-TA57-BK |
| Item Description | ZVO Premium 2.2m Olympic Bar |
| Weight | 20kg |
| Capacity | 680kg |
| Bar Diameter | 28mm |
| Length | 2.2m |
| Sleeve Length | 50mm diameter; 410mm long |

| | |
|-------------------------|-----------------------------|
| Order Code | ZVO-LBHC-2953 |
| Item Description | ZVO Olympic 1.8m Bar |
| Weight | 16.5kg |
| Capacity | 450kg |
| Bar Diameter | 30mm |
| Length | 1.8m |
| Sleeve Length | 50mm diameter; 310mm long |



| | |
|-------------------------|-----------------------------|
| Order Code | ZVO-LBHC-2954-SV |
| Item Description | ZVO Olympic 1.5m Bar |
| Weight | 13.5kg |
| Capacity | 500kg |
| Bar Diameter | 30mm |
| Length | 1.5m |
| Sleeve Length | 50mm diameter; 230mm long |



| | |
|-------------------------|------------------------------------|
| Order Code | ZVO-HCOB-2965 |
| Item Description | ZVO Olympic 76cm Tricep Bar |
| Weight | 14kg |
| Capacity | 500kg |
| Bar Diameter | 30mm |
| Length | 76cm |
| Sleeve Length | 50mm diameter; 174mm long |



| | |
|-------------------------|-------------------------------------|
| Order Code | ZVO-HCOB-2966 |
| Item Description | ZVO Olympic 1.2m EZ Curl Bar |
| Weight | 10kg |
| Capacity | 500kg |
| Bar Diameter | 30mm |
| Length | 1.2m |
| Sleeve Length | 50mm diameter; 174mm long |



| | |
|-------------------------|--------------------------------------|
| Order Code | ZVO-PBHC-2936 |
| Item Description | ZVO Olympic 1.4m Hex Trap Bar |
| Weight | 20kg |
| Capacity | 450kg |
| Bar Diameter | 25mm |
| Length | 1.4m |
| Sleeve Length | 50mm diameter; 250mm long |



| | |
|-------------------------|--------------------------------------|
| Order Code | ZVO-PBHC-1300 |
| Item Description | ZVO Olympic Open Hex Trap Bar |
| Weight | 20kg |
| Capacity | N/A |
| Bar Diameter | 25mm |
| Length | 1.4m |
| Sleeve Length | 50mm diameter; 215mm long |



SPECIALTY OLYMPIC BARS

The ZIVA® Specialty Barbells, including the Multi-Grip Swiss Bar and Squat Safety Bar, are all made with both beginners and pros in mind. Each of these heavy-duty bars come with a rust- and scratch-resistant coating and tough, Olympic-sized chrome sleeves with needle bearings for smooth rotation, but their true value lies in the greater safety and higher weights that they allow, especially for those with mobility challenges. The Multi-Grip Swiss Bar allow lifters to hit rarely reached angles while reducing stress on wrists, elbows, and shoulder joints. The Squat Safety Bar cushions necks and shoulders particularly for those with shoulder mobility issues. Both these bars are indispensable tools for seasoned lifters and those first learning to lift.



| Order Code | Item Description |
|---------------|----------------------|
| ZXP-SSBR-1503 | Safety Squat Bar |
| ZVO-PBHC-2933 | Multi-grip Swiss Bar |

| | | |
|-----------------------|--|---|
| Description | | Safety Squat Bar and Multi-grip Swiss Bar |
| Coating | | ZXP-SSBR-1503 - Premium hard chrome bar and 50mm sleeves, synthetic leather coated pads ZVO-PBHC-2933 - Black oxide coated grip area with hard chromed sleeves |
| Handle | | ZXP-SSBR-1503 - Knurled grips with needle bearings for smooth and even rotation ZVO-PBHC-2933 - Knurled grips with multiple angles for muscle isolation |
| Color Options | | <input checked="" type="checkbox"/> Chrome plus synthetic leather coated padding <input type="checkbox"/> Chrome |
| Weight Loading | | ZXP-SSBR-1503 - 350kg ZVO-PBHC-2933 - 200kg |
| Warranty | | Limited lifetime warranty |

OLYMPIC BAR STORAGE

The ZIVA® Performance Olympic Bar Storage, crafted with heavy-duty steel plate with a long-lasting, premium powder-coated finish, keeps up to 9x bars perfectly arranged in a vertical configuration that takes up minimum floor space for maximum efficiency, thus keeping even high-traffic commercial gyms well organized for a clutter free environment every visitor is bound to take note of.

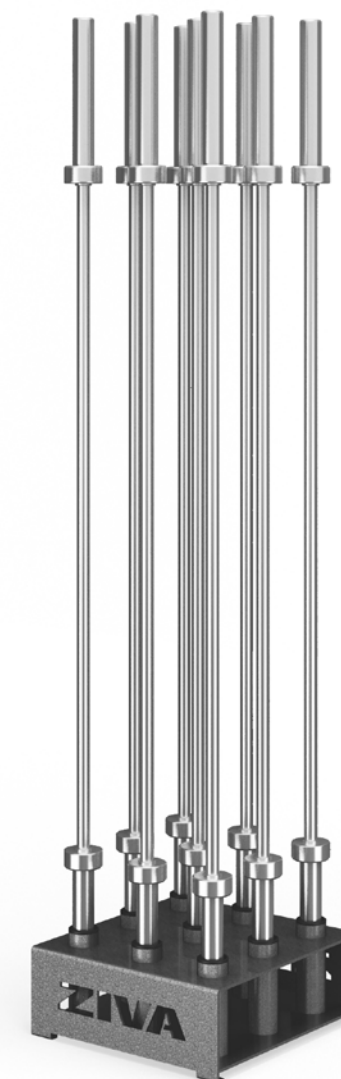

| | | |
|--------------|---------------|---------------------------|
| Order | ZXP-OBSS-7217 | Olympic Bar Storage Stand |
|--------------|---------------|---------------------------|

| | | |
|-----------------------|--|--|
| Description | | Olympic Bar Storage Stand |
| Specifications | | Olympic Bar Rack made from steel plate |
| Coating | | <input checked="" type="checkbox"/> Black powder-coated finish <input checked="" type="checkbox"/> Charcoal powder-coated finish |
| Storage | | Fits up to 9 Olympic bars |
| Dimensions | | 46cm x 46cm x 19.5cm - 32kg |
| Warranty | | Limited 10 year warranty on frames and welding, 1 year on plastic parts |





XP T-BAR HANDLE

The XP T-Bar Handle, typically used in conjunction with a landmine attachment, allows users to achieve deeper rows, higher loads, and faster development of upper back muscles. Made to slip easily onto any Olympic bar, the XP T-Bar Handle includes a unique tightening screw that locks it into place on a bar's collar. It stays firmly in place, never sliding haphazardly so users can row, rest, repeat, and even adjust weight without ever having to reset or readjust.



Order Code
ZXP-CPHD-1976

Item Description
XP T-BAR HANDLE

| | | |
|-----------------------|---|--|
| Description |  | XP T-BAR HANDLE |
| Coating |  | High-quality seamless steel pipe in black powder-coated finish |
| Color Options |  | <input checked="" type="checkbox"/> Black powder-coated finish with rubber handles |
| Weight Loading |  | 100kg |
| Warranty |  | Limited 1 year warranty |



POWER RACKS

Intense, heavy weight sessions inspire both those lifting the weights and those around to witness the lifts, and the supremely stable, safe, and sturdy equipment perfectly suited to facilitate those lifts serves as a beacon of greatness to be reached for.



Our collection of racks and platforms are heavy-duty commercial quality products designed for heavy loads and heavy use. This is where the truly impressive weights get racked, re-racked, and dropped, where the sweat pours nearly as heavy as the plates, and where athletes can feel safe and secure pushing themselves to the very limit.

The XP Power Rack with Storage and the XP Power Rack Wooden Lifting Platform serve as the ultimate benchmark for what a rack and platform combo specialized for heavy lifting should be, with the Power Rack's supremely stable structure further reinforced by the precision-bent gussets of the Lifting Platform.

The XP Half Rack Cable, meanwhile, delivers the same stability while eschewing specialization, offering instead the extreme flexibility and versatility of cable training attached directly to the traditional rack structure. This is an incredible innovation that empowers fast moving, wide-ranging routines, and that helps gyms truly make the most of their floorspace.





“

Shout out to ZIVA not only for great bright solid product in terms of quality logos and number standing out but looks super solid. I had an over sight in terms of how many plates I needed for 45 plate loaded machines and 10 power racks. They had what I was shorting in the warehouse which was 3 times my original order and had them on a truck the next day without even getting paid. Trust. Tells you a little about the company ZIVA.

Kelly Maclachlan

Gold's Gym Calgary President



”

XP POWER RACK WITH STORAGE

The ZIVA® XP Power Rack with Storage is a heavy-duty, no-nonsense training solution that empowers powerful, fast workouts thanks to its built-in storage. Made with scratch-, rust-, and corrosion-resistant powder coated thick steel tubing with laser-cut holes and numbering, a steel tube pull-up bar, and 8x chromed storage posts, this Power Rack serves as the most durable, safest and stables arena for heavy-lifting, and can be customized to create a totally tailored training platform with ZIVA XP Rig Attachments. This unique design lets gym owners increase storage and add training tools to craft a gym centerpiece that does everything they need it to do.



| Order Code | Item Description |
|---------------|----------------------------|
| ZXP-RKFL-7208 | XP Power Rack with Storage |

| | | |
|-----------------------|--|---|
| Description | | XP Power Rack with Storage |
| Specifications | | Laser-cut holes (50mm spacing) and numbering system, hard-wearing powder-coated finish 3mm thick steel 75 x 75mm frame, 24mm zinc-coated hardware, eight stainless steel bumper plate storage posts, one pair of J-Cups, additional holes at base for band or accessories attachment, must be bolted to the floor, two inside safety spotter arms (UMHW plastic protection coating) and single pull-up bar & cross beam |
| Color Options | | Charcoal roof / Charcoal frame |
| Dimensions | | 187cm x 201cm x 237cm - 224kg |
| Warranty | | Limited 10 year warranty on frames and welding; 1 year on plastic parts |

XP POWER RACK WOODEN LIFTING PLATFORM

The ZIVA® XP Power Rack Wooden Lifting Platform is the ultimate powerlifting platform. Made with notches perfectly placed to fit the ZIVA® XP Power Rack, the Platform's extended wooden center gives athletes a super-steady arena on which to perform deadlifts, squats, or bench press, while the shock absorbent rubber tiles on either side are made to handle the heavy weights for which deadlifts are famous. The entire structure is bound tightly together in a steel frame with precision bent gussets, and the entire structure can be easily bolted together and requires no bolting down.



| Order Code | Item Description |
|---------------|--|
| ZXP-PRCR-8018 | XP Power Rack Wooden Lifting Platform 50mm |

| | | |
|-----------------------|--|---|
| Description | | XP Power Rack Wooden Lifting Platform |
| Specifications | | Steel frame, laser-cut and precision bent gussets, bolt together design, rubber tiles, wood center and does not need to be bolted to the ground |
| Color Options | | Black / Wood |
| Dimensions | | 251cm x 301cm |
| Warranty | | Limited 1 year |

XP SMALL FOOT PRINT HALF RACK WITH STORAGE

The XP Small Foot Print Half Rack with Storage is the ultimate embodiment of strength packed in a small size. This Rack features 8x storage pegs for weight discs, pull-up bars with multiple grips, and comes with sturdy PVC J-cups and safety arms with a protective PVC top layer. Built from incredibly tough steel plate and tubing with a scratch- and rust-resistant black powder coat, its entire frame features laser cut holes where a variety of XP Rig Attachments and other ZIVA Accessories can attach to make this space-saving rig a total body workout hub.



Order Code
ZXP-RKHF-1831

Item Description
XP Small Foot Print Half Rack with Storage

| | | |
|-----------------------|--|---|
| Description | | XP Small Foot Print Half Rack with Storage |
| Specifications | | Laser-cut holes (50mm spacing) and numbering system, hard-wearing powder-coated finish 3mm thick steel 75 x 75mm frame, 24mm zinc-coated hardware, eight stainless steel bumper plate storage posts, one pair of J-Cups, additional holes at base for band or accessories attachment, should be bolted to the floor, two safety spotter arms (CPU plastic protection coating) and multi-grip pull-up bar & cross beam |
| Color Options | | Charcoal roof / Charcoal frame |
| Dimensions | | 141cm x 181cm x 237cm -191kg |
| Warranty | | Limited 10 year warranty on frames and welding; 1 year on plastic parts |

XP SMALL FOOT PRINT HALF RACK WOODEN LIFTING PLATFORM

The XP Small Foot Print Half Rack Wooden Lifting Platform builds on the XP Small Foot Print Half Rack with Storage to make a specialty squat and deadlift platform that maintains a smaller than normal footprint. Even with its smaller size, the Platform's wooden center provides a super-steady arena and its shock absorbent rubber tiles on either side handle the heavy weights that deadlifts and Olympic lifting are famous for. Everything is bound tightly together in a steel frame with precision bent gussets and notches perfectly placed to fit the XP Small Foot Print Half Rack with Storage, and the entire structure can be easily bolted together and requires no bolting down.



Order Code
ZXP-HRCR-3601

Item Description
XP Small Foot Print Half Rack Wooden Lifting Platform 50mm





| | | |
|-----------------------|--|---|
| Description | | XP Half Rack Wooden Lifting Platform |
| Specifications | | Steel frame, laser-cut and precision bent gussets, bolt together design, rubber tiles, wood center and does not need to be bolted to the ground |
| Color Options | | Black / Wood |
| Dimensions | | 245cm x 214cm |
| Warranty | | Limited 1 year |

XP WOODEN LIFTING PLATFORM FOR RIGS

The ZIVA XP Wooden Lifting Platform for Rigs is a specialty squat and deadlift platform made to fit any style and size of rig. This lifting platform, with a super-steady wooden center and shock absorbent rubber side tiles, is the height of versatility and usability. Specially made to handle heavy weights, its structure is reinforced by a steel frame with precision bent gussets. The XP Lifting Platform for Rigs can be easily bolted together and requires no bolting down, making it a simple and flexible addition to any gym.

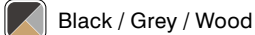
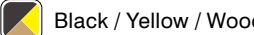

| Order Code | Item Description |
|---------------|--|
| ZXP-PRCR-8990 | XP Wooden Lifting Platform for Rigs 50mm |

| | |
|-----------------------|---|
| Description |  XP Wooden Lifting Platform for Rigs |
| Specifications |  Steel frame, laser-cut and precision bent gussets, bolt together design, rubber tiles, wood center and does not need to be bolted to the ground |
| Color Options |   Black / Grey / Wood  Black / Yellow / Wood |
| Dimensions |  251cm x 216cm |
| Warranty |  Limited 1 year |

XP HALF RACK WITH STORAGE

The ZIVA® XP Half Rack with Storage, made from thick steel tubing with a steel tube pull-up cross-bar and scratch-, rust-, and corrosion-resistant powder coating, comes with 8x chromed storage posts, 2x J-Cups, and 2x Safety Arms, but this Half Rack is more than a rack. Its laser-cut holes are made to fit the entire range of XP Rig Attachments, so it can serve not only as a heavy barbell-based training hub, but also as a versatile storage solution.



Order Code
ZXP-RKHF-7206

Item Description
XP Half Rack with Storage

| | | |
|-----------------------|--|---|
| Description | | XP Half Rack with Storage |
| Specifications | | Laser-cut holes (50mm spacing) and numbering system, hard-wearing powder-coated finish 3mm thick steel 75 x 75mm frame, 24mm zinc-coated hardware, eight stainless steel bumper plate storage posts, one pair of J-Cups, additional holes at base for band or accessories attachment, two safety spotter arms and single pull-up bar & cross beam |
| Color Options | | <input checked="" type="checkbox"/> Charcoal roof / Charcoal frame |
| Dimensions | | 187cm x 160cm x 237cm - 181kg |
| Warranty | | Limited 10 year warranty on frames and welding; 1 year on plastic parts |

XP HALF RACK WOODEN LIFTING PLATFORM

The ZIVA XP Half Rack Wooden Lifting Platform serves as a specialty squat and deadlift platform. The wooden center gives athletes a super-steady platform while the shock absorbent rubber tiles on either side are made to handle the heavy weights that deadlifts are famous for. Everything is bound tightly together in a steel frame with precision bent gussets and notches perfectly placed to fit the ZIVA XP Half Rack, and the entire structure can be easily bolted together and requires no bolting down. This platform makes gyms' Half Racks wholly attractive.



Order Code
ZXP-HRCR-8017

Item Description
XP Half Rack Wooden Lifting Platform 50mm

| | | |
|-----------------------|--|---|
| Description | | XP Half Rack Wooden Lifting Platforms |
| Specifications | | Steel frame, laser-cut and precision bent gussets, bolt together design, rubber tiles, wood center and does not need to be bolted to the ground |
| Color Options | | <input checked="" type="checkbox"/> Black / Wood |
| Dimensions | | 251cm x 255cm |
| Warranty | | Limited 1 year |

XP WALL MOUNTED HALF RACK

The XP Wall Mounted Half Rack is a pivotal piece in the XP Wall System. It puts strength training alongside functional and flexibility, so users can seamlessly move from compound barbell lifts to accessory cable movements and body weight training for synergistic gains across all training categories. The end result is the ultimate realization of what the XP Wall System has to offer: stronger lifts and better performance in less time.

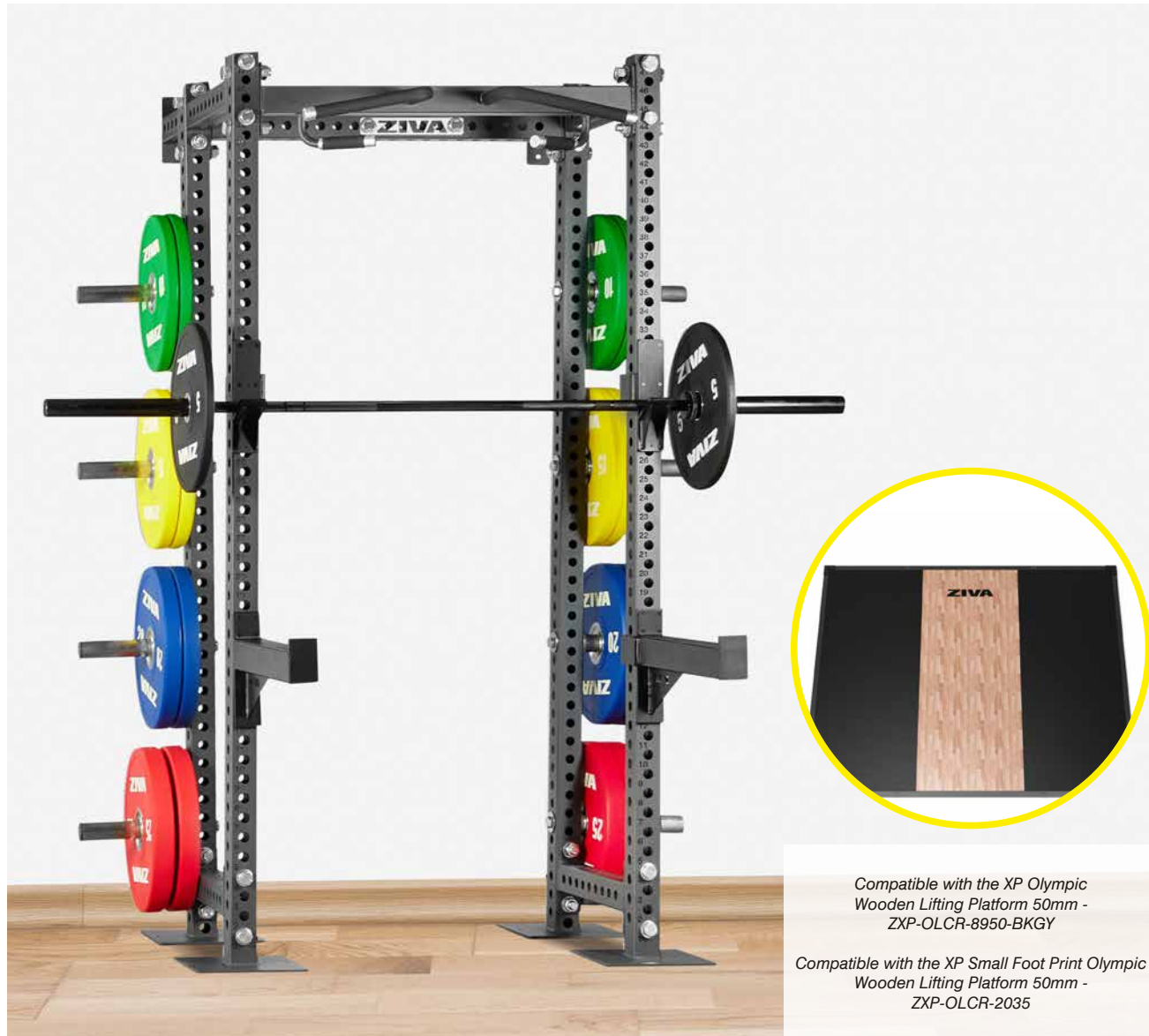

Compatible with the XP Olympic Wooden Lifting Platform 50mm - ZXP-OLCR-8950-BKGY
Compatible with the XP Small Foot Print Olympic Wooden Lifting Platform 50mm - ZXP-OLCR-2035

Order Code
ZXP-RKHF-TP33

Item Description
XP Wall Mounted Half Rack

| | | |
|-----------------------|--|--|
| Description | | XP Wall Mounted Half Rack |
| Specifications | | Made with 3mm thick steel tubing with numbered laser-cut holes, locking bolts with locking fasteners, includes 8x stainless steel storage posts, 2x safety arms with protective PU covers and 2x steel J-Cups with protective PU covers. |
| Product Color | | Charcoal roof / Charcoal frame |
| Dimensions | | 186cm x 154cm x 241cm - 155kg |
| Warranty | | Limited 10 year warranty on frames and welding, 1 year on plastic parts |

XP SMALL FOOT PRINT OLYMPIC WOODEN PLATFORM

The ZIVA XP Small Foot Print Olympic Wooden Platform gives Olympic lifters a dedicated space without sacrificing valuable floor space. This heavy-duty platform features a super stable central bamboo platform designed to give the smallest bit of flex underfoot while the shock absorbent rubber side tiles safely dissipate the incredible force of Olympic weights being dropped from overhead heights. The entire platform is tightly bound on each side with steel framing and precision bent gussets, and is easily bolted together while requiring no bolting down. For gyms looking to attract Olympic lifters and save space, this platform is a must-have.



Order Code
ZXP-OLCR-2035

Item Description
XP Small Foot Print Olympic Wooden Lifting Platform 50mm

| | | |
|-----------------------|--|---|
| Description | | XP Small Foot Print Olympic Wooden Lifting Platform |
| Specifications | | Steel frame, laser-cut and precision bent gussets, bolt together design, rubber tiles, wood center and does not need to be bolted to the ground |
| Color Options | | Black / Wood |
| Dimensions | | 240cm x 121cm |
| Warranty | | Limited 1 year |

XP SQUAT RACK

Our XP Squat Half Rack with tough 60mm laser cut steel frame and wide, stable base delivers much of the functionality of a wall- or floor-mounted rig without requiring any additional installation and taking up much less space. Users can push themselves to new limits on squat, bench press, overhead press, and more in this Rack without worrying what will happen if they have to do a rough re-rack; it is made to withstand the rigors of elite training day in, and day out. And the adjoining pull-up bar makes supersetting with pull-ups as easy as users raising their hands!



Order Code
ZXP-RKFL-7207

Item Description
XP Squat Rack

| | | |
|-----------------------|--|---|
| Description | | XP Squat Rack |
| Specifications | | Laser-cut holes (50mm spacing) and numbering system, hard-wearing powder-coated finish 3mm thick steel 75 x 75mm frame, 24mm zinc-coated hardware, one pair of J-Cups, and single pull-up bar & cross beam. <i>This is suitable to combine with XP Safety Arms.</i> |
| Color Options | | Charcoal / Charcoal |
| Dimensions | | 127cm x 160cm x 237cm - 95kg |
| Warranty | | Limited 10 year warranty on frames and welding; 1 year on plastic parts |

XP OLYMPIC WOODEN LIFTING PLATFORM

The ZIVA® XP Olympic Wooden Lifting Platform caters to the ever increasing number of athletes who practice the Olympic lift and all of its accessory movements. This ultra-heavy-duty platform features a central bamboo platform designed to give lifters the smallest measure of flex underfoot while the sides are made of shock absorbent rubber tiles made to take the extreme beating of heavy weights dropped from high heights. All panels are tightly bound in a steel frame with precision bent gussets that are easily bolted together but require no bolting down. For any gym that seeks to attract the growing crowd of Olympic lifters, this platform is a must-have.



Order Code
ZXP-OLCR-8950

Item Description
XP Olympic Wooden Lifting Platform 50mm

| | | |
|-----------------------|--|---|
| Description | | XP Olympic Wooden Lifting Platform |
| Specifications | | Steel frame, laser-cut and precision bent gussets, bolt together design, rubber tiles, wood center and does not need to be bolted to the ground |
| Color Options | | Black / Wood |
| Dimensions | | 310cm x 255cm |
| Warranty | | Limited 1 year |

XP HALF RACK CABLE

The revolutionary ZIVA® XP Half Rack & Cable is the ultimate hybrid of functionality and gym space efficiency. This innovative piece combines all the features of the XP Half Rack - its storage, its customizability, and its stability - with a seamlessly integrated cable stack, delivering unmatched versatility with an incredibly compact footprint. The Cable's smooth pulley system can be set from floor to ceiling and are compatible with all ZIVA Cable Attachments. This piece delivers an incredibly extensive range of workouts all in one tight footprint.



Compatible with the XP Small Foot Print Half Rack Wooden Lifting Platform - ZXP-HRCR-3601

Order Code
ZXP-RKHF-TP32

Item Description
XP Half Rack Cable

| | | |
|-----------------------|--|--|
| Description | | XP Half Rack Cable |
| Specifications | | Made with 3mm thick steel tubing with numbered laser-cut holes, locking bolts with locking fasteners, includes 8x stainless steel storage posts, 2x safety arms with protective PU covers and 2x steel J-Cups with protective PU covers. The cable features 2x weight stacks with a 2:1 pull ration and cable heights adjustable with a single hand. |
| Product Color | | <input checked="" type="checkbox"/> Charcoal / Grey Panels |
| Dimensions | | 181cm x 222cm x 241cm - 473kg |
| Warranty | | Limited 10 year warranty on frames and welding, 1 year on plastic parts |





Attached multi-grip pull-up bars



Precision, laser-cut holes compatible with all XP Rig Attachments



Wide, heavy base for supreme stability

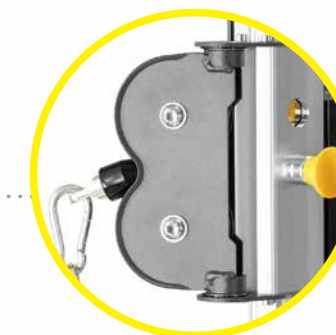

Smooth sliding cables adjustable to any height



Cables compatible with all ZVO Cable Attachments

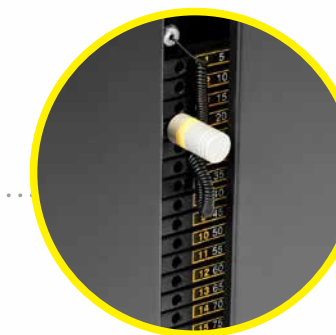

Cable set directly in rack structure for maximally efficient use of floorspace



XP WALL SYSTEM

Modularity means versatility, and versatility means the ability to meet a diverse range of workout needs, whether for functional, strength, or body weight work.





The XP Wall System offers fitness facilities a way to build workout walls that are uniquely catered to both their space and their membership. Whether they host suspension training classes or have a CrossFit focus; whether they are trying to incorporate more storage or more flexibility in their facility; whatever their aim, the XP Wall System can get them there.

The Wall consists of 4x distinct modules meant to be paired in any variety depending on a gym's needs. This includes options for heavy-duty, highly stable strength training; flexibility and body weight training; smooth sliding cable training; and storage coupled with functional fitness.

This highly versatile system is not only customizable with these 4x modules, but is also compatible with all XP Rack Attachments, opening the door to an unparalleled level of personalization.



“

At Anytime Fitness we value strong partnerships, and we truly treat our vendors, as partners. ZIVA's strong commitment to excellence, their values and expertise, are just some of the reasons we have chosen Ziva to support our growth across our International markets.

Patrick O'Brien

Director of International Vendor Relations

”



XP WALL SYSTEM

Transform underused wall space into prime gym real estate with the all-new XP Wall System. A completely customizable modular system including a Half Rack, Training Bars, Storage Rack, Calisthenic Bar, and Cable Machine, the XP Wall can be as large or as small as needed based on a given gym's space, and the modules can be mixed and matched to meet the needs of a facility's clientele and programming focus. Every piece in the XP Wall System is compatible with all existing XP Rig Attachments, giving it unparalleled functionality.

The XP Wall System can be set up for any facility's focus. It can be a functional fitness hub for group classes with ball targets, battle ropes, suspension trainer anchors, and dip stations. Make it an ultra-stable wall-anchored strength center of half racks and platforms, Jcups, safety bars, cables, and landmine attachments. Turn it into a storage depot with attachable bar, plate, and resistance band storage. Whatever a gym's needs, the XP Wall System delivers .



ZXP-SSRG-TP34
XP Wall Storage Rack

The XP Wall Storage Rack sits flush against often underutilized wall space, maximizing gyms' usable area, and storing anything and everything. From plates to dumbbells, kettlebells, bags, and balls of every size, it organizes all equipment close at hand alongside the other components of the modular XP Wall System, enabling an incredible array of workout possibilities while reducing time needed for workouts by keeping everything in one place.

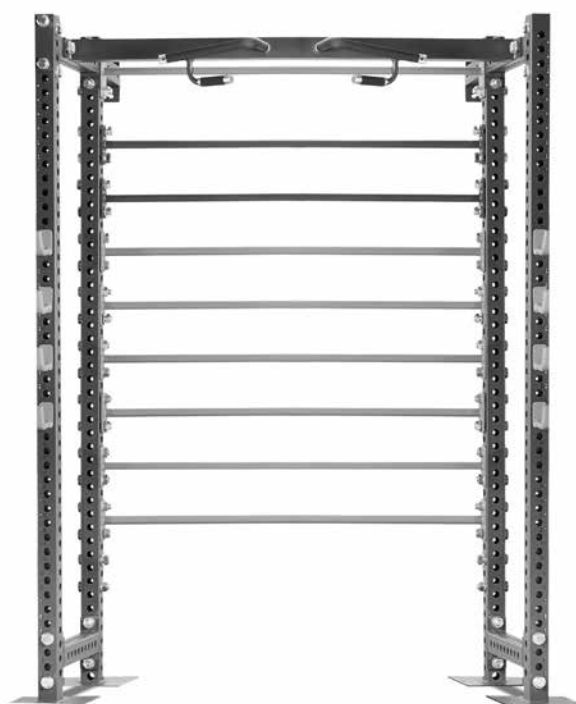

ZXP-SSRG-TP29
XP Wall Training Bars

Stretching, calisthenics, suspension training, and body weight exercise are all about anchors and angles, and XP Wall Training Bars deliver in spades. Slide resistance bands or a suspension system around any of the bars to create a workout station that accommodates several users; use the bars to get deeper stretches in any muscle group; or include challenging calisthenic movements in circuit design to make full use of all the XP Wall System has to offer.

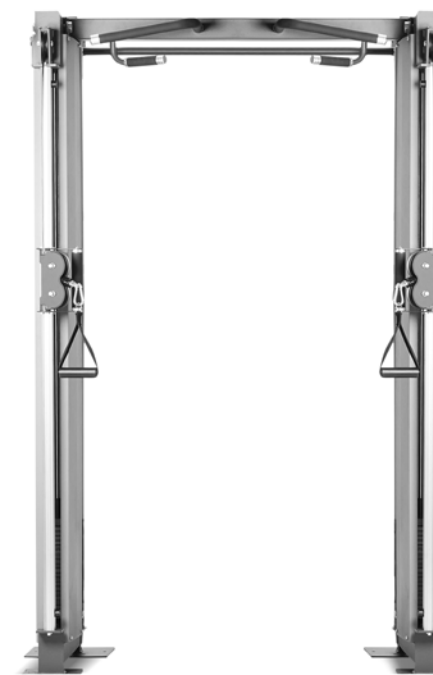

ZXP-RGAT-TP28
XP Wall Cable

The XP Wall Cable delivers all of the incredible versatility of cable with a smooth sliding pulley system, adjustable handle heights, and compatibility with all Cable Attachments. Every muscle group can be targeted from any number of angles and with any number of grips.



ZXP-RKHF-TP33
XP Wall Half Rack

The XP Wall Half Rack is a pivotal piece in the XP Wall System. It puts strength training alongside functional and flexibility, so users can seamlessly move from compound barbell lifts to accessory cable movements and body weight training for synergistic gains across all training categories. The end result is the ultimate realization of what the XP Wall System has to offer: stronger lifts and better performance in less time.



XP WALL SYSTEM POSSIBILITIES

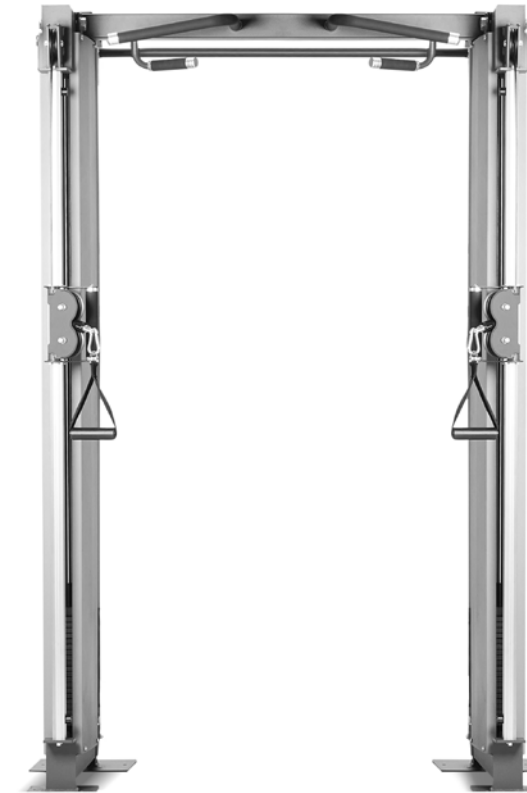

Combine calisthenics with cable training to build body weight strength and target areas for extra building ...

| Order Code | Item Description |
|---------------|------------------|
| ZXP-RGAT-TP28 | XP Wall Cable |

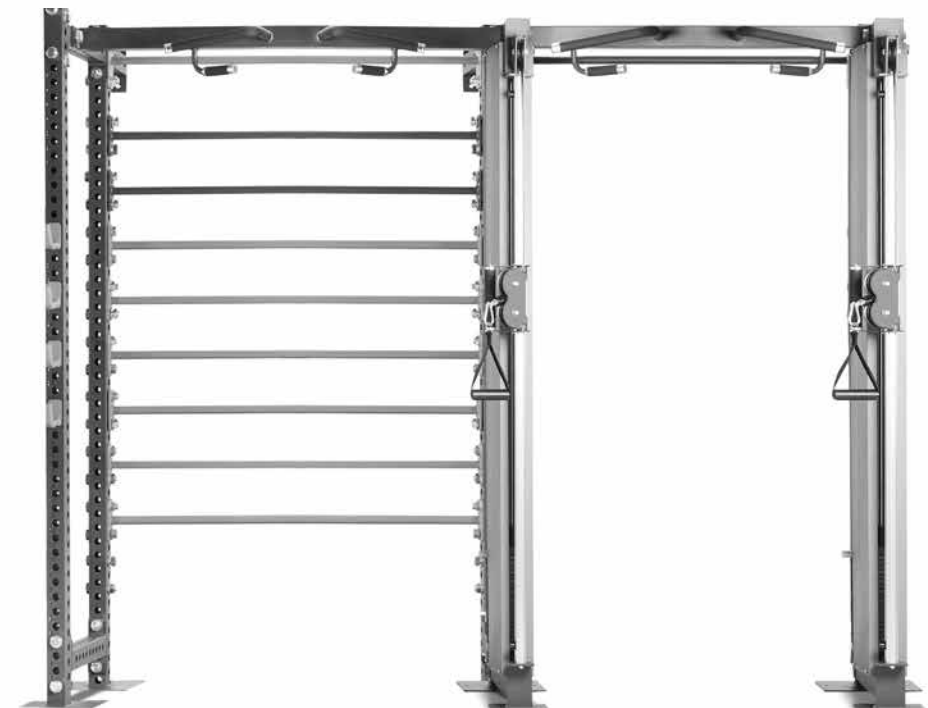

... Or join cables with suspension training for greater range of motion and more complete muscular development.

| Order Code | Item Description |
|---------------|-------------------------------|
| ZXP-SSRG-TP37 | XP Wall Cable + Training Bars |

XP WALL SYSTEM POSSIBILITIES



...Or build an all-around hub that houses resistance, stretching, and storage.

| Order Code | Item Description |
|---------------|--|
| ZXP-SSRG-TP39 | XP Wall Storage Rack + Training Bars + XP Wall Cable |



... Or double up half racks for multi-trainer squat sessions with pull-ups between sets.

| Order Code | Item Description |
|---------------|--|
| ZXP-SSRG-TP45 | XP Wall Half Rack + Single Pull Up bar + XP Wall Half Rack |



XP WALL SYSTEM POSSIBILITIES



Create a cable and suspension training station where rotational resistance rapidly builds functional fitness...

| Order Code | Item Description |
|---------------|---|
| ZXP-SSRG-TP38 | XP Wall Cable + Training Bars + XP Wall Cable |

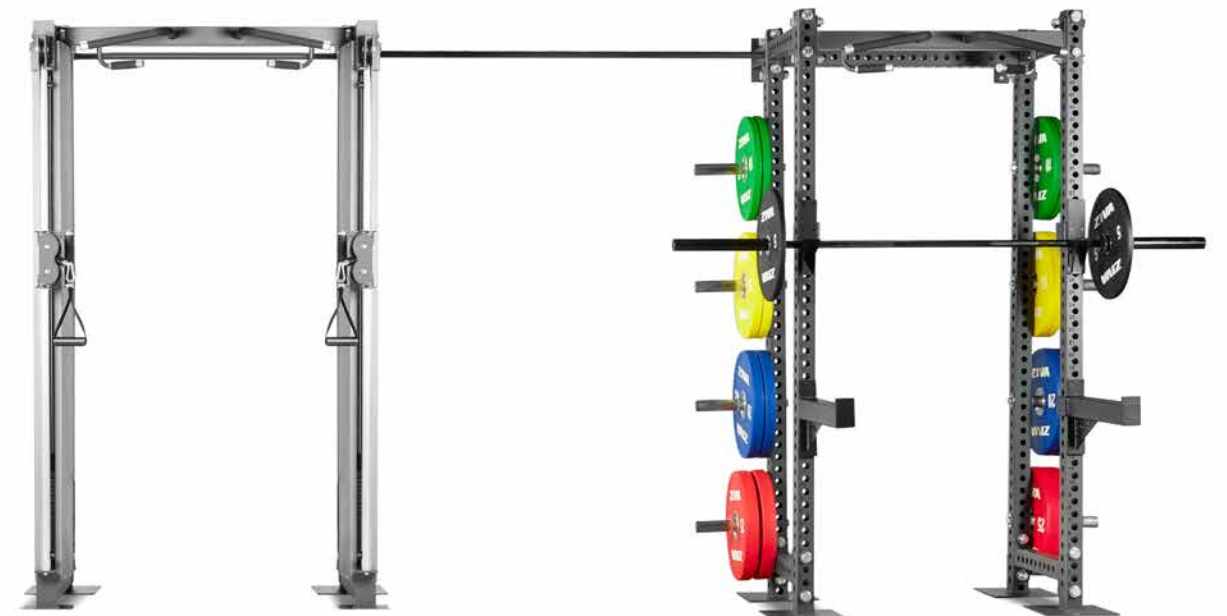

Couple cables with half racks to train powerlifting alongside all powerlifting accessory movements, with calisthenics to boot...

| Order Code | Item Description |
|---------------|--|
| ZXP-SSRG-TP40 | XP Wall Cable + Single Pull Up Bar + XP Wall Half Rack |



ZIVA

ZIVA

ZIVA

34
26
18
10
10
15

10
15
20
25
30
35

XP WALL SYSTEM POSSIBILITIES

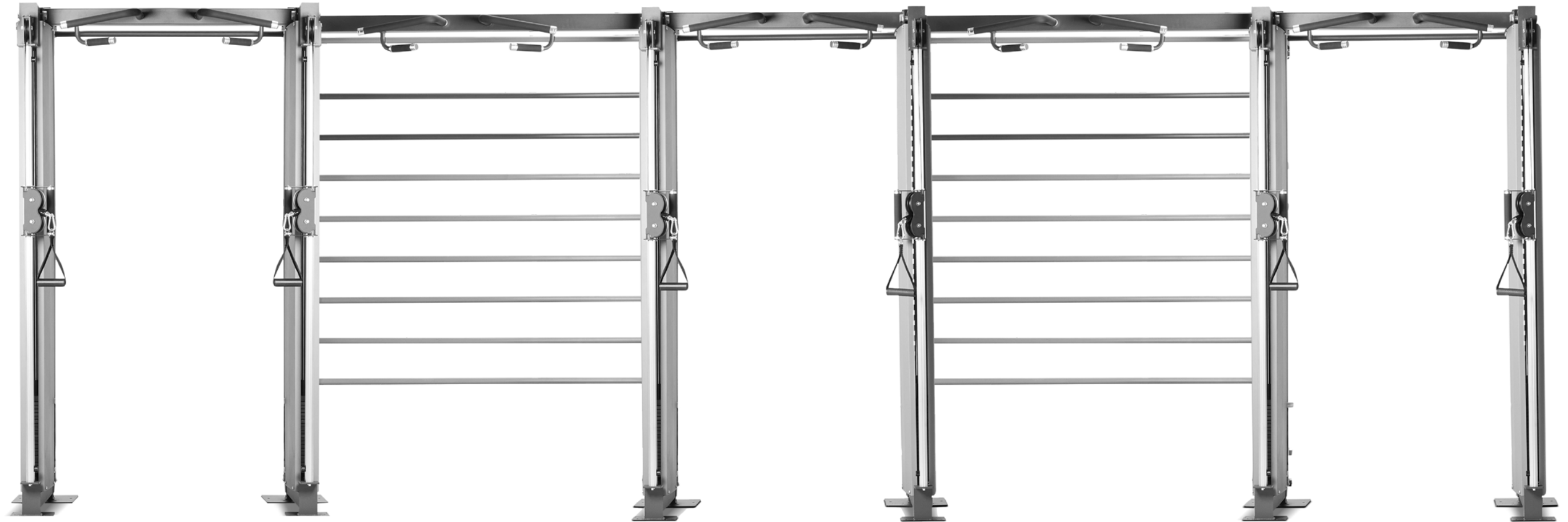

GO BIG ON **ONE THING...**

| Order Code | Item Description |
|---------------|---|
| ZXP-SSRG-TP41 | XP Wall Cable + Training Bars + XP Wall Cable + Training Bars + XP Wall Cable |

XP WALL SYSTEM POSSIBILITIES

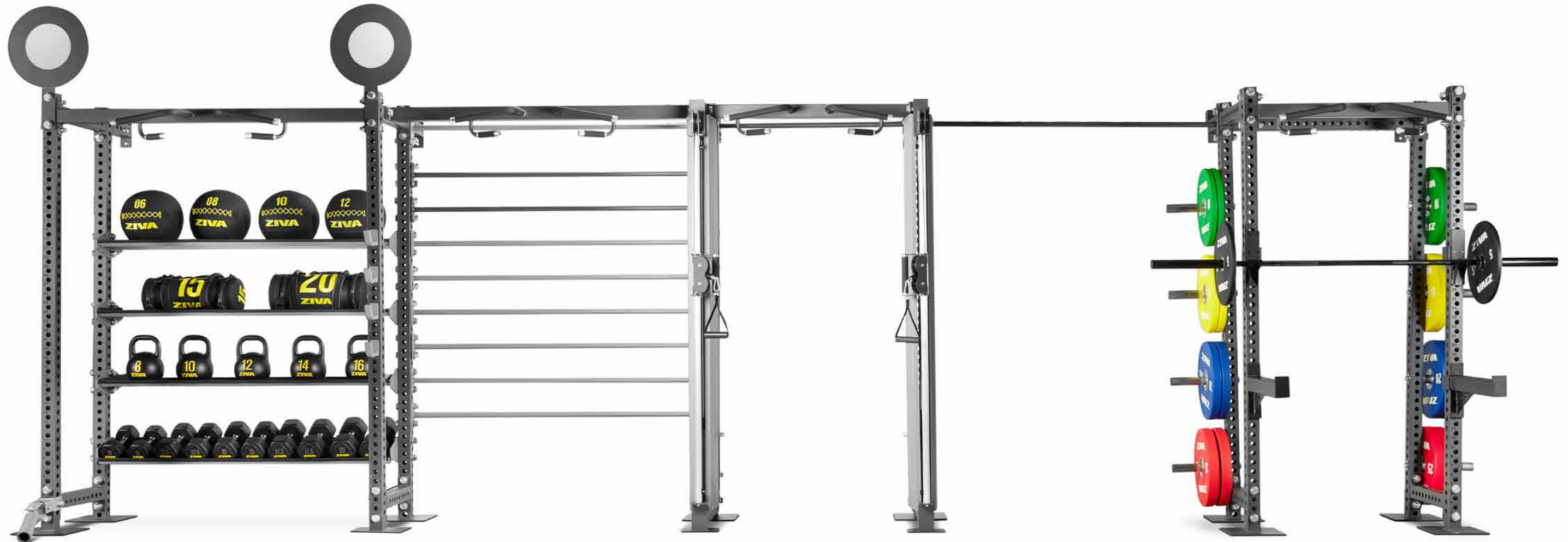

... OR GO BIG ON **VERSATILITY**

| Order Code | Item Description |
|---------------|---|
| ZXP-SSRG-TP44 | XP Wall Storage Rack + Training bars + XP Wall Cable + Single Pull Up bar + XP Wall Half Rack |

XP WALL SYSTEM POSSIBILITIES

AS **LARGE** AS YOU WANT OR AS SMALL AS YOU NEED...



... THE XP WALL SYSTEM MAKES IT POSSIBLE.



06
ZIVA

08
ZIVA

10
ZIVA

12
ZIVA

15
ZIVA

8
ZIVA

10
ZIVA

16
ZIVA

15
ZIVA

10 ZIVA 10 ZIVA 12.5 ZIVA 12.5 ZIVA 15 ZIVA 17.5 ZIVA 20 ZIVA 20 ZIVA



Order Code
ZXP-SSRG-TP34

Item Description
XP Wall Storage Rack

| | | |
|-----------------------|--|--|
| Description | | XP Wall Storage Rack |
| Specifications | | Made with 3mm thick steel tubing with 4x steel plate shelves lined with protective PU, includes 2x pairs of pull-up handles with rubber grips. |
| Product Color | | Charcoal powder-coated finish |
| Dimensions | | 209cm x 115cm x 241cm - 236kg |

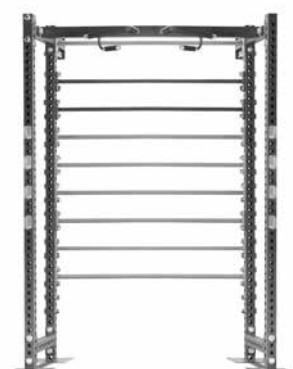

Order Code
ZXP-SSRG-TP29

Item Description
XP Wall Training Bars

| | | |
|-----------------------|--|--|
| Description | | XP Wall Training Bars |
| Specifications | | Made with 3mm thick steel tubing and 9x body weight training bars. Also includes 2x pairs of pull-up grip handles. |
| Product Color | | Charcoal powder-coated finish |
| Dimensions | | 209cm x 115cm x 241cm - 153kg |



Order Code
ZXP-RGAT-TP28

Item Description
XP Wall Cable

| | | |
|-----------------------|--|---|
| Description | | XP Wall Cable |
| Specifications | | Made with 3mm thick steel tubing with 2x pairs of pull-up grip handles. The cable features 2x weight stacks with a 2:1 pull ration and cable heights adjustable with a single hand. |
| Product Color | | Charcoal powder-coated finish |
| Dimensions | | 150cm x 123cm x 241cm - 347kg |



Order Code
ZXP-RKHF-TP33

Item Description
XP Wall Half Rack

| | | |
|-----------------------|--|--|
| Description | | XP Wall Half Rack |
| Specifications | | Made with 3mm thick steel tubing with numbered laser-cut holes, locking bolts with locking fasteners, includes 8x stainless steel storage posts, 2x safety arms with protective PU covers and 2x steel J-Cups with protective PU covers. |
| Product Color | | Charcoal powder-coated finish |
| Dimensions | | 186cm x 154cm x 241cm - 155kg |

XP RIG ATTACHMENTS

ZIVA® XP Walls are made to be customizable, with laser-cut holes specially designed to fit XP Rig Attachments. These Attachments turn XP Walls into bumper and bar storage hubs (see #8-10 below), add functional fitness features with a range of anchors and attachments (see #1, 2, 5, 7 below), and exponentially increase their value and versatility.



| Order Code | Item Description | Order Code | Item Description |
|---------------|-----------------------------|---------------|--|
| ZXP-RGAT-0983 | 1 Dip Station Attachment | ZXP-RGAT-0994 | 6 Safety Arms Attachment |
| ZXP-RGAT-0986 | 2 Ball Target Attachment | ZXP-RGAT-0101 | 7 Landmine Attachment |
| ZXP-RGAT-0993 | 3 Standard J-Cup Attachment | ZXP-RGAT-0996 | 8 Frame Mount Single Bar Storage Attachment |
| ZXP-RGAT-0973 | 4 Sandwich J-Cup Attachment | ZXP-RGAT-0961 | 9 Stainless Steel Plate Storage Peg Attachment |
| ZXP-RGAT-0987 | 5 D-Handle Attachment | ZXP-RGAT-0911 | 10 Storage hook |

| | | |
|--------------------|--|---------------------------|
| Description | | XP Cable Wall Attachments |
| Warranty | | 1 year |



RIGS

The greatest gyms help clients enjoy intense, heavy workouts in less time with rigs and storage that use great design and great construction to deliver safety and stability while keeping everything they need close at hand.



Our collection of rigs includes much, much more than simple squat racks and shelves. These are pieces that integrate storage with stretching stations, suspension training hubs, and more in aesthetic packages that look perfect alongside other ZIVA® gear. A prime example of this design philosophy in action are the XP Freestanding Space Saving Racks and the XP2 Floor-Mounted Functional Rack.

Both integrate storage alongside a lifting rack. Both offer a plethora of options for expandability and customization. Both can be turned into focal points of a fitness facility, hubs of training and storage that serve more functions than can be listed here.

These, and all other rigs in our catalog, let gyms fit more equipment and functionality into tighter spaces for maximum efficiency and floorspace flexibility.



“

ZIVA has proven to be an invaluable partner for Sweat440. Their commitment to excellence, seamless operations, and exceptional customer service have made a significant impact on our franchise network. I definitely recommend ZIVA to any fitness business looking for a reliable and high-quality equipment provider. Thank you, ZIVA, for being an integral part of our success story!

Cody Patrick

CEO

”

SWEAT  440

XP CABLE RIG

The ZIVA® XP Cable Rig is a groundbreaking fusion of traditional cable stack with the unparalleled adaptability of the XP Rig. The XP Cable component boasts a smooth-running pulley system, that ensures flawless operation with handles that can be set at any height, and it's fully compatible with all ZIVA Cable Attachments, offering endless workout possibilities. The integrated XP Rig accommodates all XP Rig Attachments — including options for storage and functional, strength, or suspension training — for extensive customization and an incredible array of functionality, transforming the way gyms are able to utilize their floor space.



Order Code
ZXP-SSRG-TP30

Item Description
XP Cable Rig

| | | |
|-----------------------|--|--|
| Description | | XP Cable Rig |
| Specifications | | Made with 3mm thick steel tubing with numbered laser-cut holes, locking bolts with locking fasteners, includes 8x stainless steel storage posts, a flying pull-up bar, 2x safety arms with protective PU covers and 2x steel J-Cups with protective PU covers. The cable features 2x weight stacks with a 2:1 pull ration and cable heights adjustable with a single hand. |
| Product Color | | Charcoal / Grey Panels |
| Dimensions | | 186cm x 237cm x 241cm - 448kg |
| Warranty | | Limited 10 year warranty on frames and welding, 1 year on plastic parts |

XP HALF RACK RIG

Designed to deliver the utmost stability and safety, the XP Half Rack Rig is made to meet the demands of heavy squats, presses, and more. It comes standard with built-in storage for Olympic plates and bumpers, making it a one-stop station for all compound lifts, but its true power lies in its versatility. Like most XP Racks and Rigs, the XP Half Rack Rig is compatible with most XP Rig Attachments and with the XP Cable Station, allowing for a wide range of customizations, maximum floor space utilization, and functionality that defies easy categorization.



Order Code
ZXP-SSRG-0784

Item Description
XP Half Rack Rig

| | | |
|-----------------------|--|---|
| Description | | XP Half Rack Rig |
| Specifications | | Made with 75*75*3mm square tubing with numbered laser-cut holes. Include 8 stainless steel storage posts, a flying pull-up bar, 2x safety arms with protective PU covers and 2x steel J-Cups with protective PU covers. |
| Product Color | | Charcoal roof / Charcoal frame |
| Dimensions | | 186cm x 139cm x 241cm - 153kg |
| Warranty | | Limited 10 year warranty on frames and welding, 1 year on plastic parts |

XP CABLE STATION

The ZIVA® XP Cable Station represents a revolutionary integration of traditional cable stack with the dynamic versatility of our XP range of rigs and racks, setting a new standard for exercise variety and space utilization. This innovative combination introduces a seamless, smooth operating pulley system to this range, thus allowing movement from XP rig and rack body weight exercises, heavy strength training, and suspension exercises, to all that a cable machine is capable of, all without having to move around the gym. It increases total gym floor efficiency, elevating the overall workout experience with previously impractical exercise pairings.



Order Code
ZXP-RGAT-0260

Item Description
XP Cable Station

| | | |
|-----------------------|--|---|
| Description | | XP Cable Station (Rig not included) |
| Specifications | | Laser-cut with powder-coated finish, 3mm thick steel frame, zinc-coated hardware, commercial grade cable and pulley system. 2 to 1 letdown ratio, 5kg increments, precision cast plates, 70kg weight stack Compatible with: ZXP-SSRG-0899, ZXP-SSRG-0919 ZXP-SSRG-0999, ZXP-SSRG-0921, ZXP-SSRG-0922, ZXP-SSRG-0923, ZXP-SSRG-0924 |
| Product Color | | <input checked="" type="checkbox"/> Grey Panels |
| Dimensions | | 120cm x 22cm x 241cm - 148kg |
| Warranty | | Limited 10 year warranty on frames and welding, 1 year on plastic parts |



XP 14' FREESTANDING SPACE SAVING RIG

The ZIVA® XP 14' Freestanding Space Saving Rig is a multi-person training hub with integrated storage that helps maximize efficient use of space. The Space Saver Rig features 2x half racks with 2x pairs of J-Cups, 2x pairs of safety arms, 2x pairs of dual-height flying pull-up bars plus one long bar in the middle, 8x chromed storage posts, 3x storage shelves, and near-infinite customization. The Rig's precision laser-cut holes are specially designed for the addition of XP Rig Attachments for expanded storage and training options to perfectly meet any gym's unique needs.



Compatible with the XP Cable Station ZXP-RGAT-0260

Order Code
ZXP-SSRG-0899
ZXP-SSPL-1510

Item Description
XP 14' Freestanding Space Saving Rig
Space Saver Rack Safety Plate 1.8m

| | | |
|-----------------------|--|--|
| Description | | XP 14' Freestanding Space Saving Rig |
| Specifications | | Made with 75mm x 75mm x 3mm commercial grade steel, and high tensile bolts. 2 pairs of J-Cups, 2 pairs of safety arms, 2 flying pull-up bars, 2 kettlebell/dumbbell storage shelves, 1 bumper storage shelf, 8 bumper pegs |
| Color Options | | Charcoal roof / Charcoal frame |
| Dimensions | | 483cm x 142cm x 243cm - 385kg |
| Warranty | | Limited 10 year warranty on frames and welding; 1 year on plastic parts |

XP 24' FREESTANDING SPACE SAVING RIG

The ZIVA® XP 24' Freestanding Space Saving Rig is a multi-person training hub with integrated storage that further maximizes efficient use of space. The Space Saver Rig features 3x half racks with all the necessary J-Cups and safety arms, 3x pull-up bars, 8x chromed storage posts, 6x storage shelves, and precision laser-cut holes designed for the addition of XP Rig Attachments. The customization this allows makes the Rig perfect for high-traffic gyms and opens the door to exciting, high-value possibilities for small-to-medium group personal training classes.



Compatible with the XP Cable Station ZXP-RGAT-0260

Order Code
ZXP-SSRG-0919
ZXP-SSPL-1510

Item Description
XP 24' Freestanding Space Saving Rig
Space Saver Rack Safety Plate 1.8m

| | | |
|-----------------------|--|--|
| Description | | XP 24' Freestanding Space Saving Rig |
| Specifications | | Made with 75mm x 75mm x 3mm commercial grade steel, and high tensile bolts. 3 pairs of J-Cups, 3 pairs of safety arms, 3 flying pull-up bars, 4 kettlebell/dumbbell storage shelves, 2 bumper storage shelf, 8 bumper pegs |
| Color Options | | Charcoal roof / Charcoal frame |
| Dimensions | | 784cm x 142cm x 243cm - 621kg |
| Warranty | | Limited 10 year warranty on frames and welding; 1 year on plastic parts |



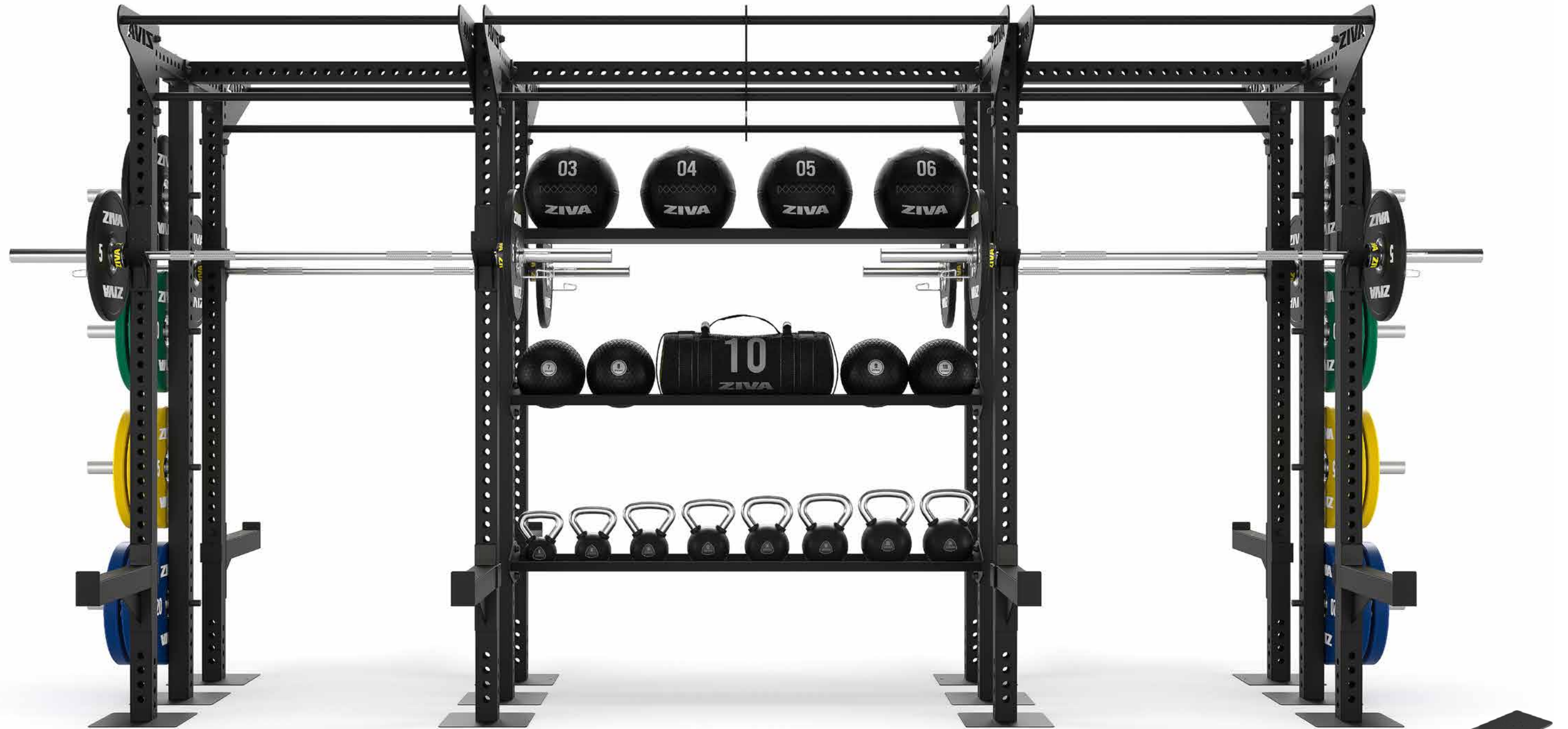

XP 14' DOUBLE-SIDED FREESTANDING SPACE SAVING RIG

The ZIVA® XP 14' Double-Sided Freestanding Space Saving Rig is a multi-person training hub with integrated storage that maximizes efficient use of space and opens the door to exciting, high-value possibilities for small-to-medium group personal training classes. The Space Saving Rig features 4x half racks with all the necessary J-Cups and safety arms, 6x pairs of dual-height flying pull-up bars plus 2x long dual-height bars in the middle, 3x storage shelves, and near-infinite customization. Precision laser-cut holes across the entire Rig allow for the addition of XP Rig Attachments for expanded storage and training options to perfectly meet any high-traffic gym's unique needs. The Rack can also be combined Double Sided Space Saving Rack Safety Plates.

| Order Code | Item Description |
|---------------|---|
| ZXP-SSRG-0792 | XP 14' Double-Sided Freestanding Space Saving Rig |
| ZXP-SSPL-1511 | Double Sided Space Saving Rig Safety Plate 2m |

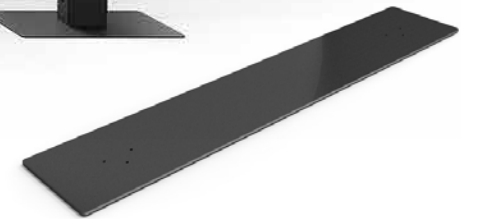

| | | |
|-----------------------|--|---|
| Description | | XP 14' Double-Sided Freestanding Space Saving Rig |
| Specifications | | Made with 75mm x 75mm x 3mm commercial grade steel, and high tensile bolts. 4 pairs of J-Cups, 4 pairs of safety arms, 6 flying pull-up bars, 2 kettlebell/dumbbell storage shelves, 1 bumper storage shelf |
| Color Options | | Charcoal roof / Charcoal frame |
| Dimensions | | 483cm x 227cm x 243cm - 655kg |
| Warranty | | Limited 10 year warranty on frames and welding; 1 year on plastic parts |



XP 24' DOUBLE-SIDED FREESTANDING SPACE SAVING RIG

For high-traffic gyms, especially those that aim to provide high-value, medium-sized personal training or CrossFit classes, the ZIVA® XP 24' Double-Sided Freestanding Space Saving Rig is the ultimate multi-person training and storage hub. 6x complete half racks, 6x pairs of dual-height flying pull-up bars plus 4x long dual-height bars, 6x storage shelves, 8x chromed storage posts, and precision laser-cut holes where XP Rig Attachments can be added for complete customization make this a hub of intense activity that elevates the atmosphere of any gym. The Rack can also be combined Double Sided Space Saving Rack Safety Plates.

Order Code

ZXP-SSRG-0780

ZXP-SSPL-1511

Item Description

XP 24' Double-Sided Freestanding Space Saving Rig

Double Sided Space Saving Rig Safety Plate 2m

| | | |
|-----------------------|--|--|
| Description | | XP 24' Double-Sided Freestanding Space Saving Rig |
| Specifications | | Made with 75mm x 75mm x 3mm commercial grade steel, and high tensile bolts. 6 pairs of J-Cups, 6 pairs of safety arms, 10 flying pull-up bars, 4 kettlebell/dumbbell storage shelves, 2 bumper storage shelf |
| Color Options | | Charcoal roof / Charcoal frame |
| Dimensions | | 781cm x 227cm x 243cm - 1061kg |
| Warranty | | Limited 10 year warranty on frames and welding; 1 year on plastic parts |

CROSSFIT



XP 9' HIGH SELF-SUPPORTED MODULAR RIGS

ZIVA® XP Self-Supported Modular Rigs are both expandable and customizable. Crafted from thick steel tubing with a scratch-, corrosion-, and rust-resistant powder coat, each section bolts into the floor with zinc-coated hardware and includes dual-height flying pull-up bars and a pair of J-Cups, and can be attached or detached piece-by-piece depending on a space's overall layout and design. The Rigs' laser-cut holes are made to fit all XP Rig Attachments so the structure can be customized for tailor-made storage and training hubs that perfectly meet a facility's unique needs. The rack can also be combined with Rigs Safety Plates.

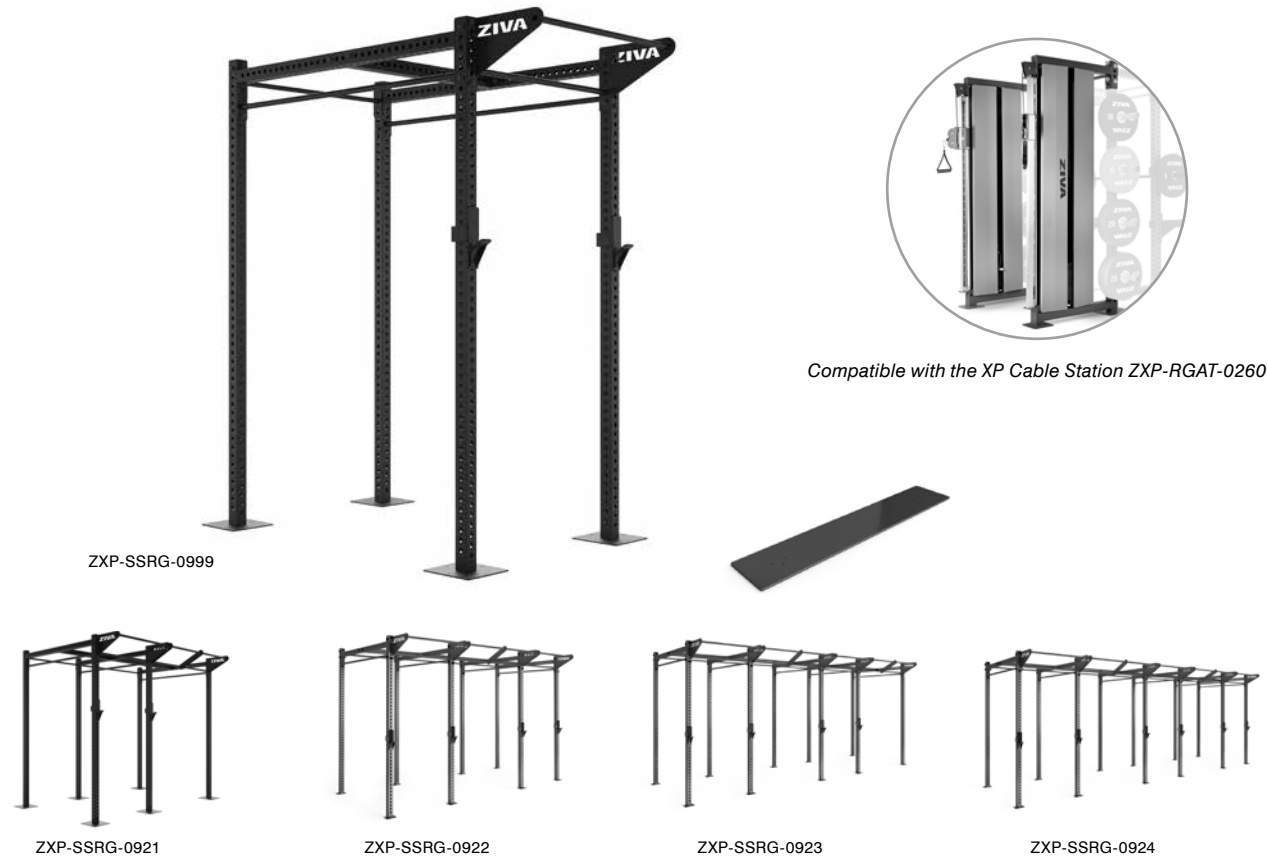

| Order Code | Item Description |
|---------------|---|
| ZXP-SSRG-0999 | XP 9' Self Supported Modular Rig (4' Station) |
| ZXP-SSRG-0921 | XP 9' Self Supported Modular Rig (10' Station) |
| ZXP-SSRG-0922 | XP 9' High Self-Supported Modular Rig (14' Station) |
| ZXP-SSRG-0923 | XP 9' Self Supported Modular Rig (20' Station) |
| ZXP-SSRG-0924 | XP 9' High Self-Supported Modular Rig (24' Station) |
| ZXP-RGSP-0962 | Rigs Safety Plate |

| | | |
|-----------------------|--|---|
| Description | | XP 9' High Self-Supported Modular Rigs |
| Specifications | | Laser-cut with powder-coated finish, 3mm thick steel 75 x 75mm frame, 24mm zinc-coated hardware, 4' section x 6' section, includes one pair of J-Cups for each 4' wide rigs, includes flying dual-height pull-up bars for each rigs section |
| Color Options | | Charcoal roof / Charcoal frame |
| Dimensions | | ZXP-SSRG-0999 - 122cm x 183cm x 271cm - 145kg ZXP-SSRG-0921 - 327cm x 183cm x 271cm - 195kg ZXP-SSRG-0922 - 446cm x 183cm x 271cm - 300kg ZXP-SSRG-0923 - 625cm x 183cm x 271cm - 389kg ZXP-SSRG-0924 - 744cm x 183cm x 271cm - 468kg |
| Warranty | | Limited 10 year warranty on frames and welding; 1 year on plastic parts |

XP 9' HIGH WALL-MOUNTED MODULAR RIGS

ZIVA® Wall-Mounted Modular Rigs are expandable and customizable, and zinc-coated hardware to bolt directly into walls to help maximize efficient use of space. Crafted from thick steel tubing with a scratch-, corrosion-, and rust-resistant powder coat, each section includes dual-height flying pull-up bars and a pair of J-Cups, and can be attached or detached piece-by-piece depending on a space's overall layout and design. The Rigs' laser-cut holes are made to fit all XP Rig Attachments for tailor-made storage and training hubs made to match any gym's unique needs.

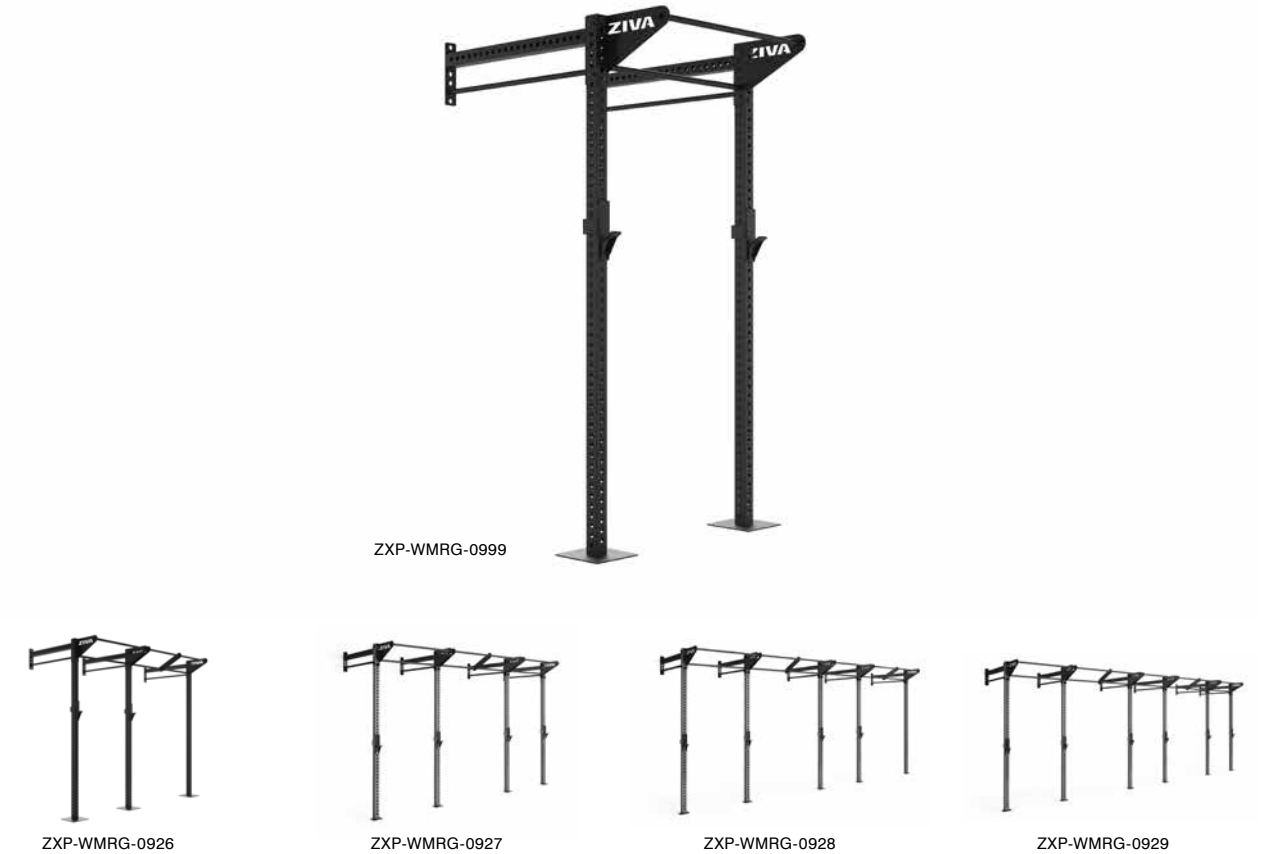

| Order Code | Item Description |
|---------------|---|
| ZXP-WMRG-0999 | XP 9' Wall-Mounted Modular Rig (4' Station) |
| ZXP-WMRG-0926 | XP 9' Wall-Mounted Modular Rig (10' Station) |
| ZXP-WMRG-0927 | XP 9' High Wall-Mounted Modular Rig (14' Station) |
| ZXP-WMRG-0928 | XP 9' Wall-Mounted Modular Rig (20' Station) |
| ZXP-WMRG-0929 | XP 9' High Wall-Mounted Modular Rig (24' Station) |

| | | |
|-----------------------|--|--|
| Description | | XP 9' High Wall-Mounted Modular Rigs |
| Specifications | | Laser-cut with powder-coated finish, 3mm thick steel 75 x 75mm frame, 24mm zinc-coated hardware, 4' section x 6' section, includes one pair of J-Cups for each 4' wide rigs, includes flying dual-height pull-up bars for each rigs section |
| Product Color | | Charcoal roof / Charcoal frame |
| Dimensions | | ZXP-WMRG-0999 - 122cm x 122cm x 274cm- 90kg ZXP-WMRG-0926 - 305cm x 122cm x 274cm- 107kg ZXP-WMRG-0927 - 427cm x 122cm x 274cm- 165kg ZXP-WMRG-0928 - 610cm x 122cm x 274cm- 213kg ZXP-WMRG-0929 - 732cm x 122cm x 274cm - 256kg |
| Warranty | | Limited 10 year warranty on frames and welding; 1 year on plastic parts |

XP SPACE SAVING WALL-MOUNTED RIGS

XP Space Saving Wall-Mounted Rigs are expandable and customizable with a slimmer profile than their larger sibling. These Rigs come with zinc-coated hardware to bolt directly into walls to help further maximize efficient use of space. Crafted from thick steel tubing with a scratch-, corrosion-, and rust-resistant black powder coat, each section includes dual-height flying pull-up bars and a pair of J-Cups, and can be attached or detached piece-by-piece depending on a space's overall layout and design. The Rigs' laser-cut holes are made to fit all XP Rig Attachments so gym owners can create tailor-made storage and training hubs made to match their unique needs.



ZXP-WMRG-5313



ZXP-WMRG-2031



ZXP-WMRG-2032







ZXP-WMRG-2033



ZXP-WMRG-2034

| Order Code | Item Description |
|---------------|--------------------------------------|
| ZXP-WMRG-5313 | XP Space Saving 4' Wall-Mounted Rig |
| ZXP-WMRG-2031 | XP Space Saving 10' Wall-Mounted Rig |
| ZXP-WMRG-2032 | XP Space Saving 14' Wall-Mounted Rig |
| ZXP-WMRG-2033 | XP Space Saving 20' Wall-Mounted Rig |
| ZXP-WMRG-2034 | XP Space Saving 24' Wall-Mounted Rig |

| | |
|-----------------------|--|
| Description |  XP Space Saving Wall-Mounted Rigs |
| Specifications |  Laser-cut with powder-coated finish, 3mm thick steel 75 x 75mm frame, 24mm zinc-coated hardware, 4' section x 6' section, includes one pair of J-Cups for each 4' wide rigs, includes flying dual-height pull-up bars for each rigs section |
| Color Options |  <input checked="" type="checkbox"/> Charcoal roof / Charcoal frame |
| Dimensions |  ZXP-WMRG-5313 - 122cm x 117cm x 271cm - 78kg ZXP-WMRG-2031 - 327cm x 117cm x 271cm - 122kg ZXP-WMRG-2032 - 446cm x 117cm x 271cm - 300kg ZXP-WMRG-2033 - 625cm x 117cm x 271cm - 389kg ZXP-WMRG-2034 - 744cm x 117cm x 271cm - 468kg |
| Warranty |  Limited 10 year warranty on frames and welding; 1 year on plastic parts |



XP 9' 4-SHELF STORAGE SYSTEM

For high-traffic gyms where space is at a premium, the ZIVA® XP 9' 4-Shelf Storage System offers incomparable flexibility. It easily serves as a storage hub for plates, kettle- or dumbbells, balls, and suspension or cable attachments, but can also be used as an immovable rack for squats, overhead press, or bench. Its most unique feature is its ability to fit all XP Rig Attachments thanks to precision laser-cut holes all along its 8x posts, allowing complete customizability that makes this piece a hub of intense activity to elevate the atmosphere of any gym.

Order Code
ZXP-RGAT-0980

Item Description
XP 9' 4 Shelves Storage System

| | | |
|-----------------------|--|---|
| Description | | XP 9' 4 Shelves Storage System |
| Specifications | | Made with 75mm x 75mm x 3mm commercial grade steel, and high tensiles bolts. It comes with 2 kettlebell/dumbbell storage shelves, 1 x bumper/ball storage shelf & 1 x Accessories Storage |
| Color Options | | Charcoal roof / Charcoal frame |
| Dimensions | | 208cm x 35cm x 256cm - 135kg |
| Warranty | | Limited 10 year warranty on frames and welding; 1 year on plastic parts |

XP RIG ATTACHMENTS

ZIVA® XP Rigs are made to be customizable, featuring laser-cut holes specially designed to fit XP Rig Attachments. These Attachments turn XP Rigs into storage for balls, bells, and bumpers; add functional fitness functionality with a range of anchors and attachments; and exponentially increase the value and versatility of a gym's rigs and space.

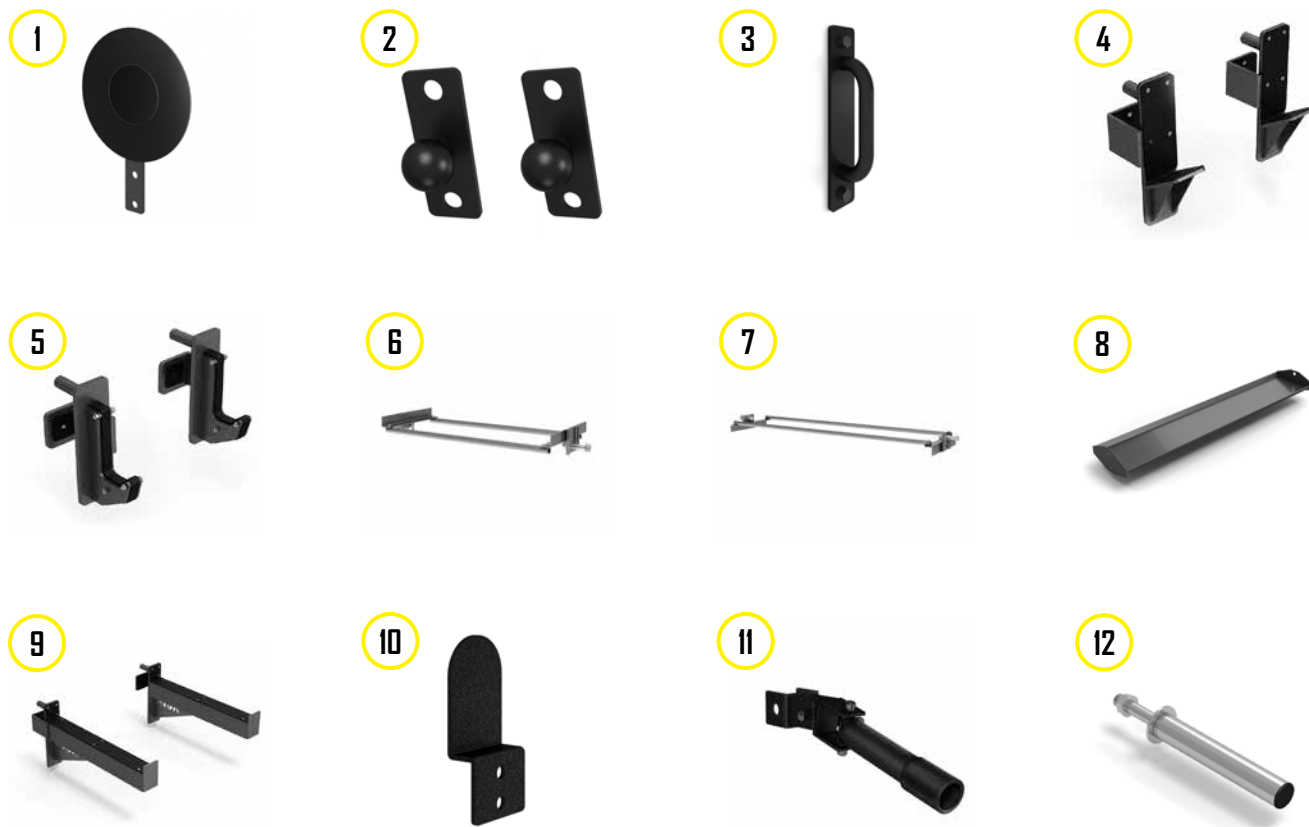

| Order Code | Item Description | Order Code | Item Description |
|---------------|--------------------------------------|------------------|--|
| ZXP-RGAT-0986 | 1 XP Ball Target Attachment | ZPX-RGAT-0971 | 8 XP Kettlebell/Dumbbell Storage Shelf 72" |
| ZXP-RGAT-0991 | 2 XP Pull-Up Ball Attachment | ZXP-RGAT-0994 | 9 XP Safety Arms Attachment |
| ZXP-RGAT-0987 | 3 XP D-Handle Attachment | ZXP-RGAT-0979 | 10 XP Battle Rope Storage Attachment |
| ZXP-RGAT-0993 | 4 XP J-Cup Attachment | ZXP-RGAT-0101 | 11 XP Landmine Attachment |
| ZXP-RGAT-0973 | 5 XP Sandwich J-Cup Attachment | ZXP-RGAT-0995-SV | 12 XP Chrome Plate Storage Peg Attachment |
| ZXP-RGAT-0937 | 6 XP Core-Fit Ball Storage Shelf 42" | ZXP-RGAT-0961-SV | 13 XP Stainless Steel Plate Storage Peg Attachment |
| ZXP-RGAT-0938 | 7 XP Core-Fit Ball Storage Shelf 72" | ZXP-RGAT-0957 | 14 XP Roof Mount Olympic Bar Storage (3 bars) |

| | | |
|--------------------|--|--------------------|
| Description | | XP Rig Attachments |
| Warranty | | 1 year |

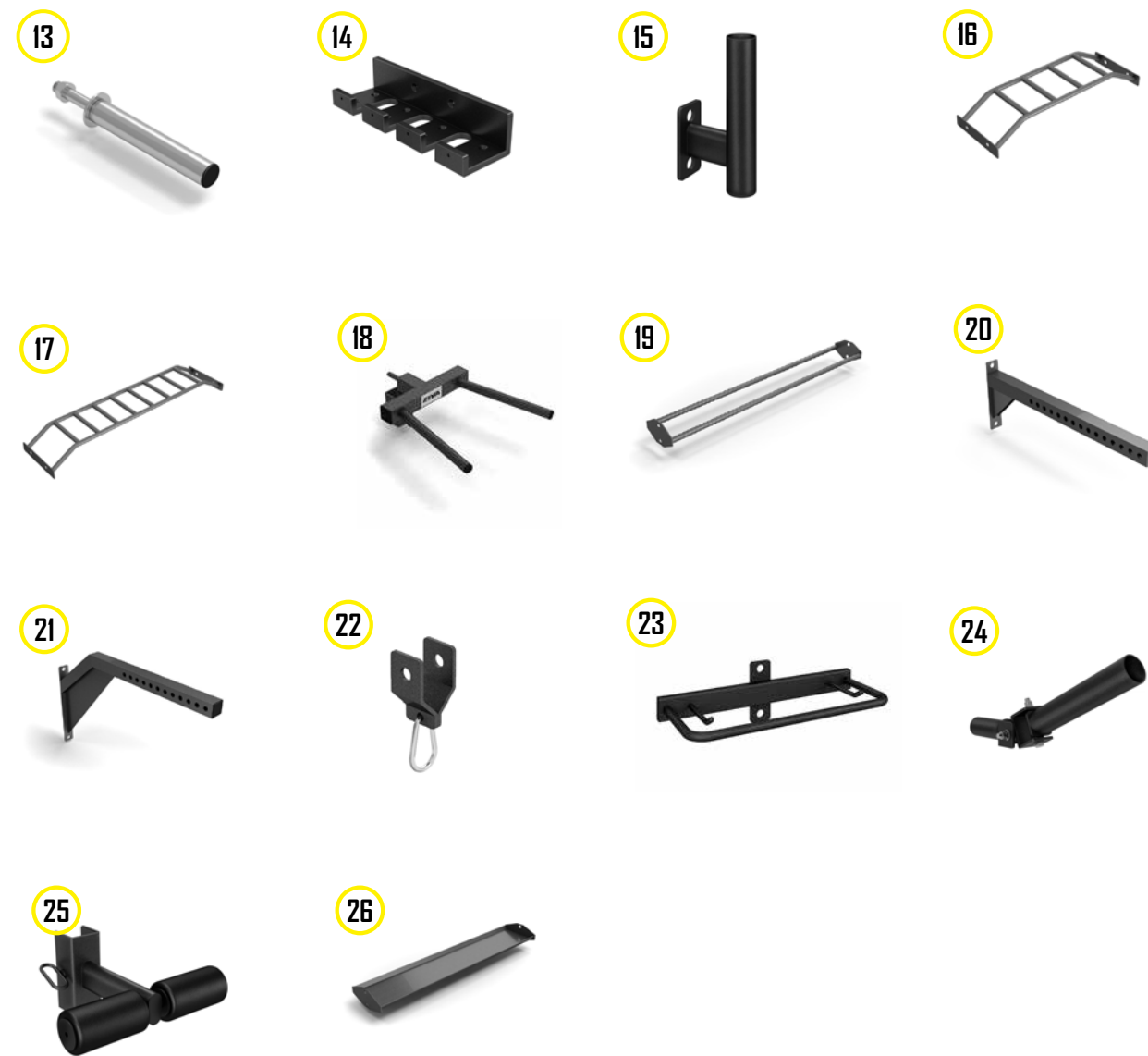

| Order Code | Item Description | Order Code | Item Description |
|---------------|--|---------------|---|
| ZXP-RGAT-0996 | 15 XP Frame Mount Single Bar Storage Attachment | ZXP-RGAT-0999 | 21 XP Flat Arm Cantilever Accessory Extension Attachment |
| ZXP-RGAT-0997 | 16 XP 4' Multigrip Crossbar | ZXP-RGAT-0988 | 22 XP Frame Mount Accessory Shackle w/ Carabiner Attachment |
| ZXP-RGAT-0998 | 17 XP 6' Multigrip Crossbar | ZXP-RGAT-0967 | 23 XP Mat Storage Attachment |
| ZXP-RGAT-0983 | 18 XP Dip Station Attachment | ZXP-RGAT-0694 | 24 XP Steel Power Pivot Plate Landmine Attachment |
| ZXP-RGAT-0972 | 19 XP Bumper Disc / XP 6' Ball Storage Shelf | ZXP-RGAT-0020 | 25 XP Removable Thigh Pad Attachment |
| ZXP-RGAT-0960 | 20 XP Angled Arm Cantilever Accessory Extension Attachment | ZXP-RGAT-0768 | 26 XP Kettlebell/Dumbbell Storage Shelf 42" |

| | | |
|--------------------|--|--------------------|
| Description | | XP Rig Attachments |
| Warranty | | 1 year |



ZIVA

ZVO URETHANE CABLE ATTACHMENTS

ZVO Urethane Cable Attachments are the best of the best for materials, construction, and design but their real strength lies in how light they are. These Cable Attachments do not weigh down the pulley and make the weight or handle height more difficult to adjust; they do not damage cable machines when they inevitably swing into them; and they do not hurt if and when users accidentally bonk themselves with them. And their skin with all around texturing adds the functional benefit of being super grippy, giving users greater endurance for greater gains.

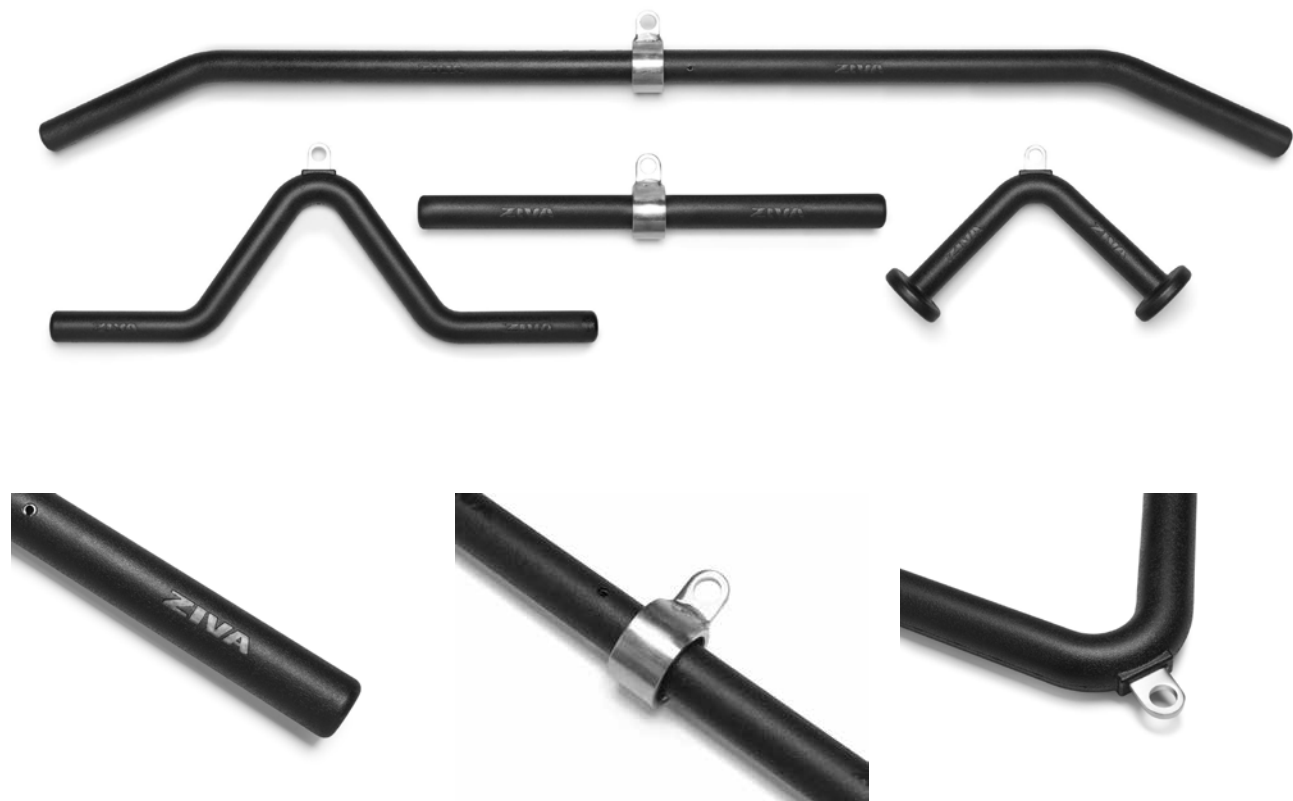

| Order Code | Item Description | Order Code | Item Description |
|---------------|---|---------------|--|
| ZVO-SRDH-6619 | Premium Urethane Seated Row Double Handle | ZVO-PLBR-6512 | Premium Urethane Short Lat Bar Handle - 76cm |
| ZVO-LTBR-6511 | Premium Urethane Long Lat Bar - 120cm | ZVO-MTBR-6514 | Premium Urethane Multi-Exercise Bar |
| ZVO-TCSB-6616 | Premium Urethane Straight Tricep Bar - 43cm | ZVO-ATCB-6620 | Premium Urethane Angled Tricep Bar |
| ZVO-CBHD-6621 | Premium Urethane Stirrup Handle | ZVO-TCVR-6513 | Premium Urethane Bent Tricep Bar - 54cm |

| | | |
|-----------------------|--|------------------------------------|
| Description | | ZVO Urethane Cable Attachments |
| Specifications | | Assorted cable station attachments |
| Handle | | Premium urethane bars |
| Color Options | | Black |
| Warranty | | Limited 5 year warranty |

ST ACCESSORY BOX

The ST Accessory Box from ZIVA® is the ultimate organizational solution for all the accessories, odds, and ends that always seem to be looking for a well-designed home in the gym. Designed to house a wide range of gym accessories — from ab wheels and resistance bands to Olympic barbell clamps and dip belts — this storage box addresses the common challenge of cluttered gym floors. Its construction not only offers a designated spot for every piece of equipment but also enhances the overall look of your gym with ZIVA's signature premium design. The ST Accessory Box ensures a tidier, safer workout environment and a seamless visual experience, embodying ZIVA's commitment to excellence in both form and function.



| Order Code | Item Description |
|---------------|------------------|
| ZVO-SBXC-0100 | ST Accessory Box |

| | | |
|-----------------------|--|--|
| Description | | ST Accessory Box |
| Specifications | | 50mm diameter round tubing and 2mm thick steel |
| Color Options | | Black |
| Dimensions | | 145cm x 50cm x 75cm - 70kg |
| Warranty | | Limited 10 year warranty on frames and welding, 1 year on rubber parts |

XP CUSTOMISED RIGS

When it comes to deciding on a Rig system for your gym, sometimes customisation is what counts. Different facilities have different spatial requirements and different clientele have different goals.

At ZIVA, we aim to help every gym build the system that is right for them.

Here are the questions that will help you better know what you need:

1. Where will you put the rig and what dimensions do you want it to take up?
2. Do you need it to be wall-mounted or freestanding?
3. Do you want it to be accessible from only one side, or do you want it to be double-sided?
4. What are the needs of your members and what XP Rig Attachments will address those needs?

Whatever your needs, we are here to help you fulfill them.

Available in custom colors and configurations.
Call for further details.



XP2 FLOOR-MOUNTED FUNCTIONAL RACK

The ZIVA® XP2 Floor-Mounted Functional Rack takes the traditional squat bay used for heavy barbell movements and combines it with storage and customizability. Crafted using commercial-grade thick steel tube and plate, the storage portion of this rig includes 4x shelves made to fit dumbbells, kettlebells, and functional training equipment, and 1x shelf specially made for large wall or core fit balls. The squat bay, built with the same ultra-durable commercial-grade materials, comes with a pair of J-Cups and safety arms, and can be added onto with the entire range of XP2 Accessories for additional storage and/or functional fitness pieces. Pull-up bars span the entire structure and an included punching bag and suspension point further make the XP2 Floor-Mounted Functional Rack a gym centerpiece designed to meet a variety of needs.



ZXP-SSRG-0318-BK



ZXP-SSRG-0317-BK

| Order Code | Item Description |
|------------------|----------------------------------|
| ZXP-SSRG-0316-BK | XP2 Floor-Mounted Squat + 6' Rig |
| ZXP-SSRG-0317-BK | XP2 Floor-Mounted Storage Rig 6' |
| ZXP-SSRG-0318-BK | XP2 Floor-Mounted Squat Unit |

Note: You must purchase the ZXP-SSRG-0316 as the base unit, then add on ZXP-SSRG-0317 or ZXP-SSRG-0318 as needed

| | | |
|-----------------------|--|--|
| Description | | XP2 Floor-Mounted Functional Rack |
| Specifications | | Made with commercial-grade 3mm tubing, laser-cut and welded. Utilizing thick plate steel for the shelving. Full commercial quality. Includes 1 pair of J-Cups & safety arms. Boxing bag and suspension points included with a max weight of 150kg. |
| Color Options | | <input checked="" type="checkbox"/> Black powder-coated finish |
| Warranty | | Limited 10 year warranty on frames and welding; 1 year on plastic parts |

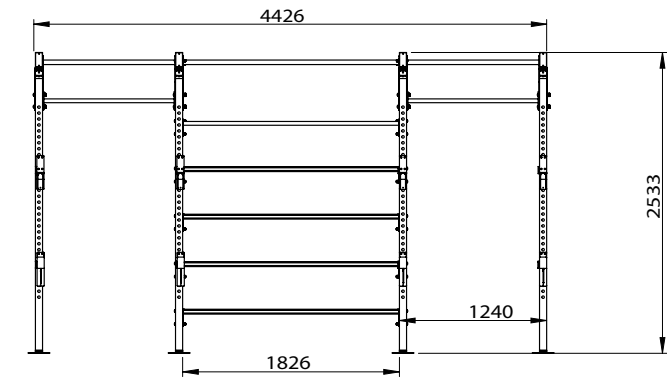

| Order Code | Item Description |
|------------------|---|
| ZXP-SSRG-0688-BK | XP2 Floor-Mounted 1x Functional Racks + 2x Squat Bays |

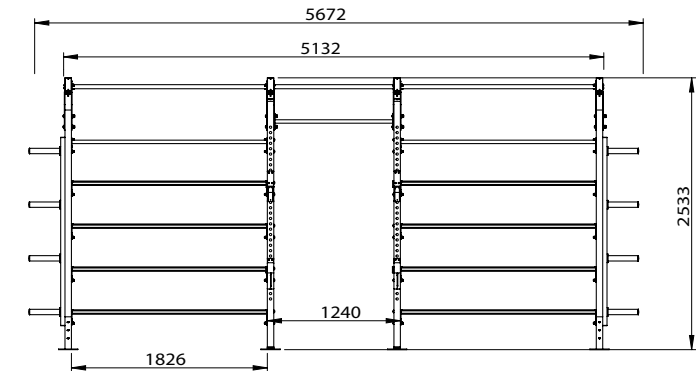

| Order Code | Item Description |
|------------------|---|
| ZXP-SSRG-0788-BK | XP2 Floor-Mounted 2x Functional Racks + 1x Squat Bays |

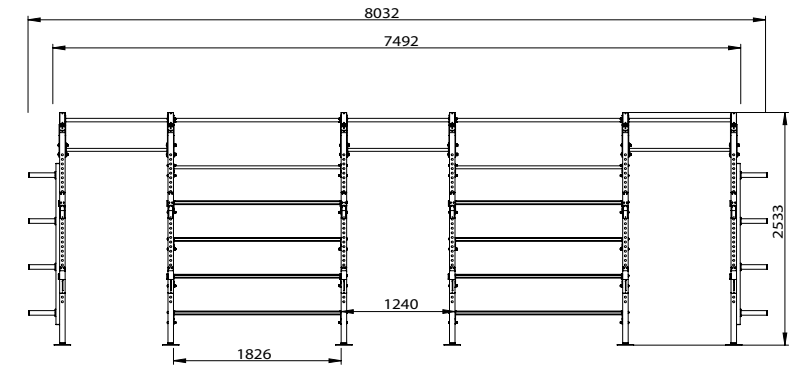

| Order Code | Item Description |
|------------------|---|
| ZXP-SSRG-0787-BK | XP2 Floor-Mounted 2x Functional Racks + 3x Squat Bays |

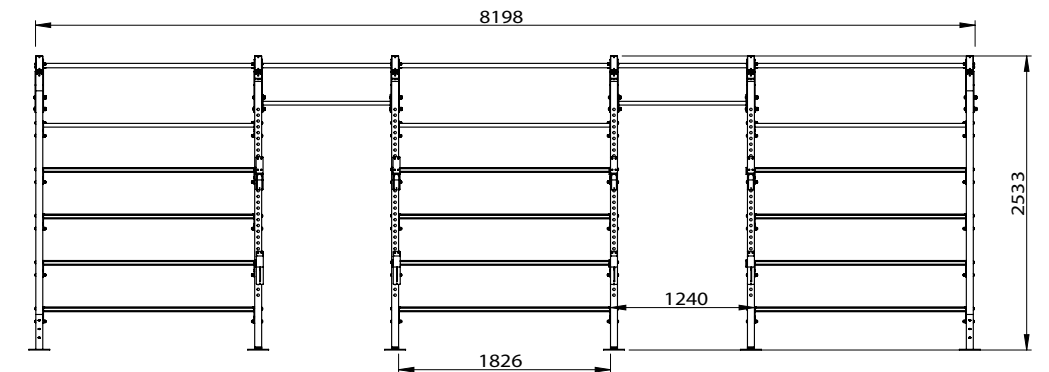

| Order Code | Item Description |
|------------------|--|
| ZXP-SSRG-0397-BK | XP Floor-Mounted 3x Functional Racks + 2x Squat Bays |



55
ZIVA

55
ZIVA

55
ZIVA

02
ZIVA

04
ZIVA

06
ZIVA

08
ZIVA

06

08

10

12

15

8
ZIVA

8
ZIVA

12
ZIVA

12
ZIVA

16
ZIVA

16
ZIVA

20
ZIVA

20
ZIVA

24
ZIVA

8
ZIVA

10
ZIVA

12
ZIVA

14
ZIVA

16
ZIVA

18
ZIVA

20
ZIVA

ZIVA
BOXING
- LEBENSWEIT -

XP2 ACCESSORIES

All ZIVA® XP2 pieces are designed to accommodate these steel plate XP2 Accessories with corrosion-, rust-, and scratch-resistant black powder coating. The Accessories range from additional storage for barbells, bands, and dumbbells, to additional anchor points for suspension trainers, resistance bands, and battle ropes, and equipment that enables an even broader range of functional training exercises. These customization options mean that each XP2 can be tailor-made to suit the unique needs of any high-traffic gym.



Compatible with the XP2 Corner

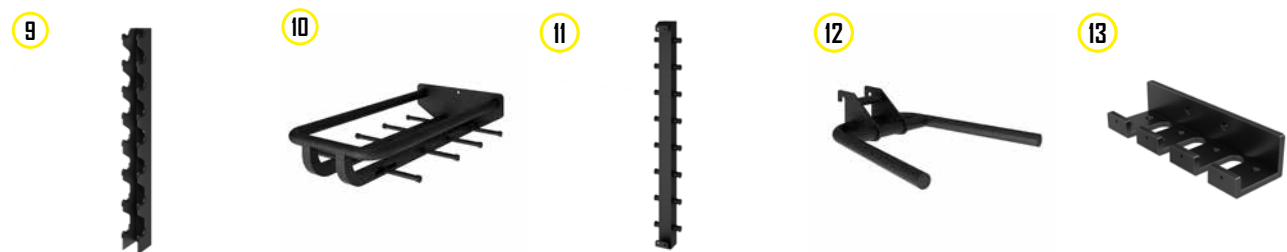

| Order Code | Item Description | Order Code | Item Description |
|------------------|--|-------------------|--|
| ZXP-RGAT-4746-BK | 1 XP2 Resistance Band Anchor | ZXP-RGAT-4785-BK | 8 XP2 J-Cups |
| ZXP-RGAT-4748-BK | 2 XP2 Ball Target | ZXP-RGAT-4747-BK | 9 XP2 Vertical Dumbbell Storage - 5 Pair |
| ZXP-RGAT-4750-BK | 3 XP2 Double Play - Bar & Plate Storage | ZXP-RGAT-4749-BK | 10 XP2 Ball & Hanging Storage Extension |
| ZXP-RGAT-4753-BK | 4 XP2 Battle Rope Anchor | ZXP-RGAT-4751-BK | 11 XP2 Attachment Anchor |
| ZXP-RGAT-4754-BK | 5 XP2 Hanging Storage Hook | ZXP-RGAT-4752-BK* | 12 XP2 Dip Attachment |
| ZXP-RGAT-4755-BK | 6 XP2 Horizontal Mount Ground Rotational Trainer | ZXP-RGAT-9806-BK | 13 XP2 Roof-Mounted Olympic Bar Storage (3 Bars) |
| ZXP-RGAT-4784-BK | 7 XP2 Safety Arms | | |

Note: ZXP-RGAT-4752-BK cannot be used without ZXP-RGAT-4751-BK

FUNCTIONAL

Beautifully built functional fitness equipment designed to inspire. Balls, bags, boxes, bars, and every piece of essential equipment for the modern functionally focused premium fitness facility.





Our functional fitness equipment has always looked great, but now with a fully unified aesthetic language speaking across every piece, this equipment is the perfect fusion of form and function. ZIVA® has been crafting functional fitness pieces since functional fitness was a concept, and our experience has helped us refine our pieces and our process so that our current offerings are more usable and longer lasting than any others available.

This focus on perfect performance is matched with great looking design that isn't limited to the workout equipment; it's been equally applied to all our functional fitness storage solutions, as well. This is crystal clearly demonstrated with our Storage Trees: sleek, slim profiles clad in black with rugged, ultra-long-lasting steel tube shelving that not only organizes but displays these aesthetically advanced pieces of equipment, maximizing usable floorspace while cutting clutter and beautifying the overall gym environment.



“

We rely on ZIVA for all our free weights and functional equipment needs. Excellent equipment, good value and great service from ZIVA at a local level. Delivery times have kept up with our aggressive build program and we are a happy customer. I like the fact ZIVA keeps evolving with the changing trends in the industry and endeavor to stay ahead of the curve.

Mike Lamb

CEO

”

jetts[®]
24 hour fitness

ZEL ZEP **EX FUNCTIONAL TRAINING STATION**

The ZIVA® EX Functional Training Station offers the ultimate combination of storage, display, stretching, and training. A central pull-up bar allows for several grip variations; 8x adjustable PVC-lined shelves store and display functional training equipment; 2x vertical bars serve as anchors for rope and stretching; 2x specialized suspension trainer anchors round out its offering; and a TV bracket lets gyms turn this into a total training solution. Precision designed to transform typically wasted corners into premium athletic attractions, the EX Functional Training Station serves as an immediate signal to all visitors that a gym is head and shoulders above the competition.



Order Code
ZEX-SSMF-0770

Item Description
EX Functional Training Station

| | | |
|-----------------------|--|---|
| Description | | EX Functional Training Station |
| Specifications | | 200mm wide main frame, full commercial 3mm thick steel, 16mm bolts, floor mounted with safety extensions for extra stability, hard-wearing powder coating <i>Note: Shelving positions can be changed to suit your own set up</i> With pull-up bar, 2 x suspension points, 2 x rope pull bars, TV Bracket (TV not included) |
| Product Color | | Black powder-coated finish |
| Storage | | Fits wall balls, medicine balls, power core bags, slam balls, kettle bells, dumbbells, and all small accessories |
| Dimensions | | 331cm x 210cm x 235cm - 440kg |
| Warranty | | Limited 10 year warranty on frames and welding, 1 year on plastic parts |

XP FUNCTIONAL CORNER

The ZIVA® XP Functional Corner transforms often difficult to utilize corner spaces into training and storage hubs. This innovative piece, crafted with commercial-grade steel tubing and thick plate steel, with reinforced welding across the entire frame, includes stretching and pull-up bars, a multitude of anchor points for suspension and resistance band training equipment, 8x PVC-lined shelves, hooks for holding compatible yoga mats, and it comes with a range of options that allow for extensive expansion, both for storage and for exercise. Alone, the XP Functional Corner is an optimal solution for maximal space utilization. Combined with additional XP Accessories, it can turn previously forgotten corners into the backbone of great gyms.



Order Code
ZXP-XCRN-0285

Item Description
XP Functional Corner 8' (243cm)

| | | |
|-----------------------|--|--|
| Description | | XP Functional Corner |
| Specifications | | Made with commercial-grade 3mm tubing, laser-cut and welded. Utilizing thick plate steel for the shelving. Commercial quality. |
| Product Color | | Black powder-coated finish |
| Dimensions | | ZXP-XCRN-0285 227cm x 227cm x 243cm - 450kg |
| Warranty | | Limited 10 year warranty on frames and welding; 1 year on plastic parts |

ZEL ZEP EX FUNCTIONAL STRETCH STATION

The ZIVA® EX Functional Stretch Station transforms often underutilized corner spaces into stretching and cool down hotspots. The Station offers shelf space for storage and display; a versatile stretching ladder that allows for stretching from nearly any angle; 2x specialized suspension trainer anchors; 2x vertical bars for anchoring ropes or other equipment, or for stretching; brackets for mat storage; a pull-up bar; and TV bracket that lets gyms turn this Station into a digital personal trainer. With heavy-duty 3mm thick steel construction and scratch- and wear-resistant black powder coating, this is an athletic attraction that is built to last.



Order Code: ZEX-SSMF-0771
 Item Description: EX Functional Stretch Station

| | | |
|-----------------------|--|---|
| Description | | EX Functional Stretch Station |
| Specifications | | 200mm wide main frame, full commercial 3mm thick steel, 16mm bolts, floor mounted with safety extensions for extra stability, hard-wearing powder coating <i>Note: Shelving positions can be changed to suit your own set up</i> With pull-up bar, 2 x suspension points, 2 x rope pull bars, TV Bracket (TV not included) |
| Product Color | | Black powder-coated finish |
| Storage | | Fits yoga balls, balance balls, mats, small accessories |
| Dimensions | | 331cm x 210cm x 235cm - 390kg |
| Warranty | | Limited 10 year warranty on frames and welding, 1 year on plastic parts |





Stores 4x or 6x pairs of dumbbells, 2x kettlebells, and resistance bands



High density molded PU foam pad



Smooth rolling PU wheels make moving around the gym easy



Bench can be set both flat or at an 80° incline



Anchor points on either side for suspension trainers and resistance bands

EX FUNCTIONAL BENCH (4-PAIR DUMBBELLS)

The ZIVA® EX Functional Bench is a marvel of versatility. It serves to store up to 4x pairs of dumbbells, 2x kettlebells, and any number of resistance bands; it is a supremely stable flat bench that easily lifts to an 80° incline bench; and its heavy-duty handle serves as an anchor for resistance bands and battle ropes, turning it into a complete workout hub. Crafted from plate steel and steel tubing with a thick, comfortable foam cushioned bench, the Functional Bench also includes built-in wheels that make it easy to move from one place to another despite its powerful construction.

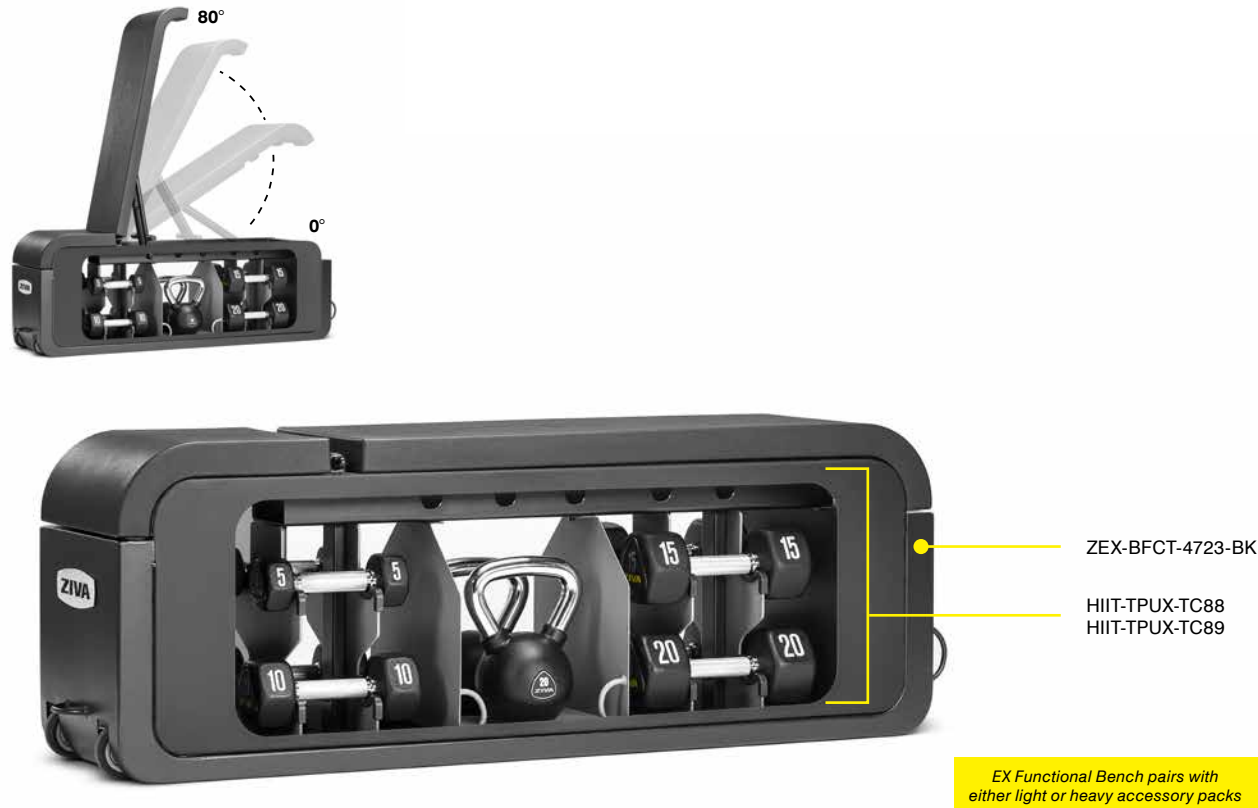

| Order Code | Item Description |
|------------------|---|
| ZEX-BFCT-4723-BK | EX Functional Bench (4-Pair Dumbbells) |
| HIIT-TPUX-TC88 | EX Functional Bench Light Accessory Pack: - 4 Pair of HIIT Hexagon Urethane Dumbbell: 2.5/5/7.5/10kg - 2 Piece of SL Virgin Rubber Kettlebell: 8/16kg - 1 Set of Resistant Band (4 Pair) |
| HIIT-TPUX-TC89 | EX Functional Bench Heavy Accessory Pack: - 4 Pair of HIIT Hexagon Urethane Dumbbell: 7.5/10/12.5/15kg - 2 Piece of SL Virgin Rubber Kettlebell: 8/16kg - 1 Set of Resistant Band (4 Pair) |

| | | |
|-----------------------|--|--|
| Description | | EX Functional Bench (4-Pair Dumbbells) |
| Specifications | | Made with thick steel reinforced frame, angled seat back to 80 degrees for comfort and safety, high quality cushion surface with double stitches for better stability. Multiple resistant band attachment points. Moving wheels included. Stores 4x pairs dumbbells, 2 x kettlebells, and resistant bands. |
| Weight Loading | | 200kg |
| Product Color | | Black powder-coated finish |
| Dimensions | | 117cm x 34cm x 41.5cm - 62kg |
| Warranty | | Limited 5 year warranty on frames and welding, 1 year on plastic parts, 90 days on pads |

EX FUNCTIONAL BENCH (6-PAIR DUMBBELLS)

The ZIVA® EX Functional Bench is an expanded marvel of versatility. It serves to store up to 6x pairs of dumbbells, 2x kettlebells, and any number of resistance bands; it is a supremely stable flat bench that easily lifts to an 80° incline bench; and its heavy-duty handle serves as an anchor for resistance bands and battle ropes, turning it into a complete workout hub. Crafted from plate steel and steel tubing with a thick, comfortable foam cushioned bench, the Functional Bench also includes built-in wheels that make it easy to move from one place to another despite its powerful construction.

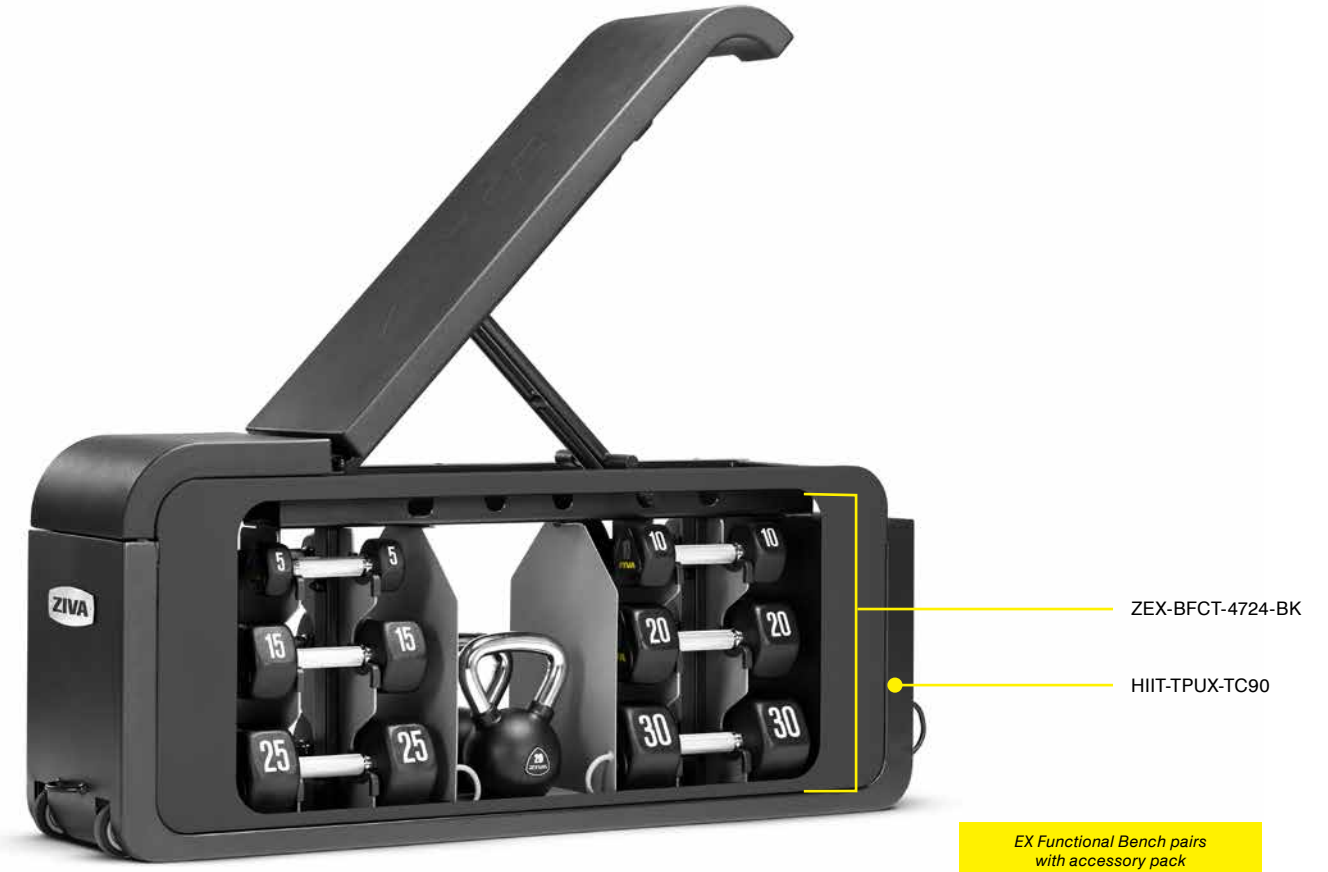

| Order Code | Item Description |
|------------------|---|
| ZEX-BFCT-4724-BK | EX Functional Bench (6-Pair Dumbbells) |
| HIIT-TPUX-TC90 | EX Functional Bench Accessory Pack: - 6 Pair of HIIT Hexagon Urethane Dumbbell: 2.5/5/7.5/10/12.5/15kg - 2 Piece of SL Virgin Rubber Kettlebell: 8/16kg - 1 Set of Resistant Band (4 Pair) |

| | | |
|-----------------------|--|--|
| Description | | EX Functional Bench (6-Pair Dumbbells) |
| Specifications | | Made with thick steel reinforced frame, angled seat back to 80 degrees for comfort and safety, high quality cushion surface with double stitches for better stability. Multiple resistant band attachment points. Moving wheels included. Stores 6x pairs dumbbells, 2 x kettlebells, and resistant bands. |
| Weight Loading | | 200kg |
| Product Color | | Black powder-coated finish |
| Dimensions | | 130cm x 32cm x 56cm - 68kg |
| Warranty | | Limited 5 year warranty on frames and welding, 1 year on plastic parts, 90 days on pads |



ZIVA

10 10

10 10

15 15

15 15

20 20

20 20

25 25

25 25

15 15

20 20

25 25

30 30

35 35

40 40

45 45

50 50

15 15

20 20

25 25

30 30

35 35

40 40

45 45

50 50

20" 81cm

24" 61cm

75cm

30"

51cm

ZIVA



ZVO MEDICINE BALLS 2.0

The ZVO Medicine Ball 2.0 takes a timeless, tried-and-true training tool and made it tougher, longer lasting, and better looking. The Ball's textured easy-grip premium rubber outer shell has been made more durable and its color stays more vibrant than ever before, guaranteeing that the large weight IDs pop so users can quickly grab the right one and go for years to come. In intense functional fitness training and HIIT sessions, users will be able to build total body strength, explosivity, and sport-specific power with these exceptionally beautiful Medicine Balls.



| Order Code | Item Description | Order Code | Item Description |
|---------------|-----------------------------|---------------|------------------------------|
| ZVO-CMMB-9061 | ZVO Medicine Ball 2.0 - 2kg | ZVO-CMMB-9066 | ZVO Medicine Ball 2.0 - 7kg |
| ZVO-CMMB-9062 | ZVO Medicine Ball 2.0 - 3kg | ZVO-CMMB-9067 | ZVO Medicine Ball 2.0 - 8kg |
| ZVO-CMMB-9063 | ZVO Medicine Ball 2.0 - 4kg | ZVO-CMMB-9068 | ZVO Medicine Ball 2.0 - 9kg |
| ZVO-CMMB-9064 | ZVO Medicine Ball 2.0 - 5kg | ZVO-CMMB-9069 | ZVO Medicine Ball 2.0 - 10kg |
| ZVO-CMMB-9065 | ZVO Medicine Ball 2.0 - 6kg | | |

| | | |
|-----------------------|--|--------------------------------|
| Description | | ZVO Medicine Ball 2.0 |
| Specifications | | Made with premium rubber |
| Color Options | | Black / Yellow Black / Grey |
| Increments | | 1kg increments from 2kg - 10kg |
| Warranty | | Limited 1 year warranty |

ZVO DUAL GRIP MEDICINE BALL

The ZIVA® ZVO Grip Medicine Ball takes a timeless tried-and-true training tool and brings it into the modern age with modern materials, and upgrades usability with the addition of easy to grip handles on either side. The Ball's textured easy-grip premium rubber outer shell comes stamped with large weight IDs so users can quickly identify and grab the right weights during intense HIIT sessions. Users will build total body strength, explosivity, and sport-specific power and will be proud doing it with these exceptionally beautiful Medicine Balls.



| Order Code | Item Description | Order Code | Item Description |
|---------------|---------------------------------|---------------|----------------------------------|
| ZVO-DGMB-9230 | ZVO Dual Grip Medicine Ball 3kg | ZVO-DGMB-9234 | ZVO Dual Grip Medicine Ball 7kg |
| ZVO-DGMB-9231 | ZVO Dual Grip Medicine Ball 4kg | ZVO-DGMB-9235 | ZVO Dual Grip Medicine Ball 8kg |
| ZVO-DGMB-9232 | ZVO Dual Grip Medicine Ball 5kg | ZVO-DGMB-9236 | ZVO Dual Grip Medicine Ball 9kg |
| ZVO-DGMB-9233 | ZVO Dual Grip Medicine Ball 6kg | ZVO-DGMB-9237 | ZVO Dual Grip Medicine Ball 10kg |

| | | |
|-----------------------|--|--------------------------------|
| Description | | ZVO Dual Grip Medicine Ball |
| Specifications | | Made with premium rubber |
| Color Options | | Black / Yellow Black / Grey |
| Increments | | 1kg increments from 3kg - 10kg |
| Warranty | | Limited 1 year warranty |







ZVO SLAM BALL

Full-body strength and endurance; intense, explosive cardio; and challenging rotational core exercises combine in one durable, elite-level tool guaranteed to push performance to its absolute limits. The ZVO Slam Ball features a weighted, sand-filled center wrapped in a tough PVC shell with gripping tire tread skin, and is made to be thrown with abandon over and over again. Overhead slams, woodchoppers, Russian twists, and more unique full-body exercises test the limits of users' core strength and endurance while building shoulder, chest, arm, and leg muscle in a holistic fashion that includes often neglected supporting and stabilizer muscles.



| Order Code | Item Description | Order Code | Item Description |
|---------------|-------------------|---------------|--------------------|
| ZVO-SPSB-6870 | ZVO Slam Ball 2kg | ZVO-SPSB-6878 | ZVO Slam Ball 10kg |
| ZVO-SPSB-6871 | ZVO Slam Ball 3kg | ZVO-SPSB-6879 | ZVO Slam Ball 12kg |
| ZVO-SPSB-6872 | ZVO Slam Ball 4kg | ZVO-SPSB-6880 | ZVO Slam Ball 15kg |
| ZVO-SPSB-6873 | ZVO Slam Ball 5kg | ZVO-SPSB-6881 | ZVO Slam Ball 18kg |
| ZVO-SPSB-6874 | ZVO Slam Ball 6kg | ZVO-SPSB-6882 | ZVO Slam Ball 20kg |
| ZVO-SPSB-6875 | ZVO Slam Ball 7kg | ZVO-SPSB-6883 | ZVO Slam Ball 25kg |
| ZVO-SPSB-6876 | ZVO Slam Ball 8kg | ZVO-SPSB-6884 | ZVO Slam Ball 30kg |
| ZVO-SPSB-6877 | ZVO Slam Ball 9kg | ZVO-SPSB-6886 | ZVO Slam Ball 35kg |

| | | |
|-----------------------|---|--|
| Description |  | ZVO Slam Ball |
| Specifications |  | Made with premium hard-wearing PVC |
| Color Options |  | Black / Yellow Black / Grey |
| Increments |  | 1kg increments from 2kg - 10kg, various weight increments from 12kg up to 35kg |
| Warranty |  | Limited 1 year warranty |

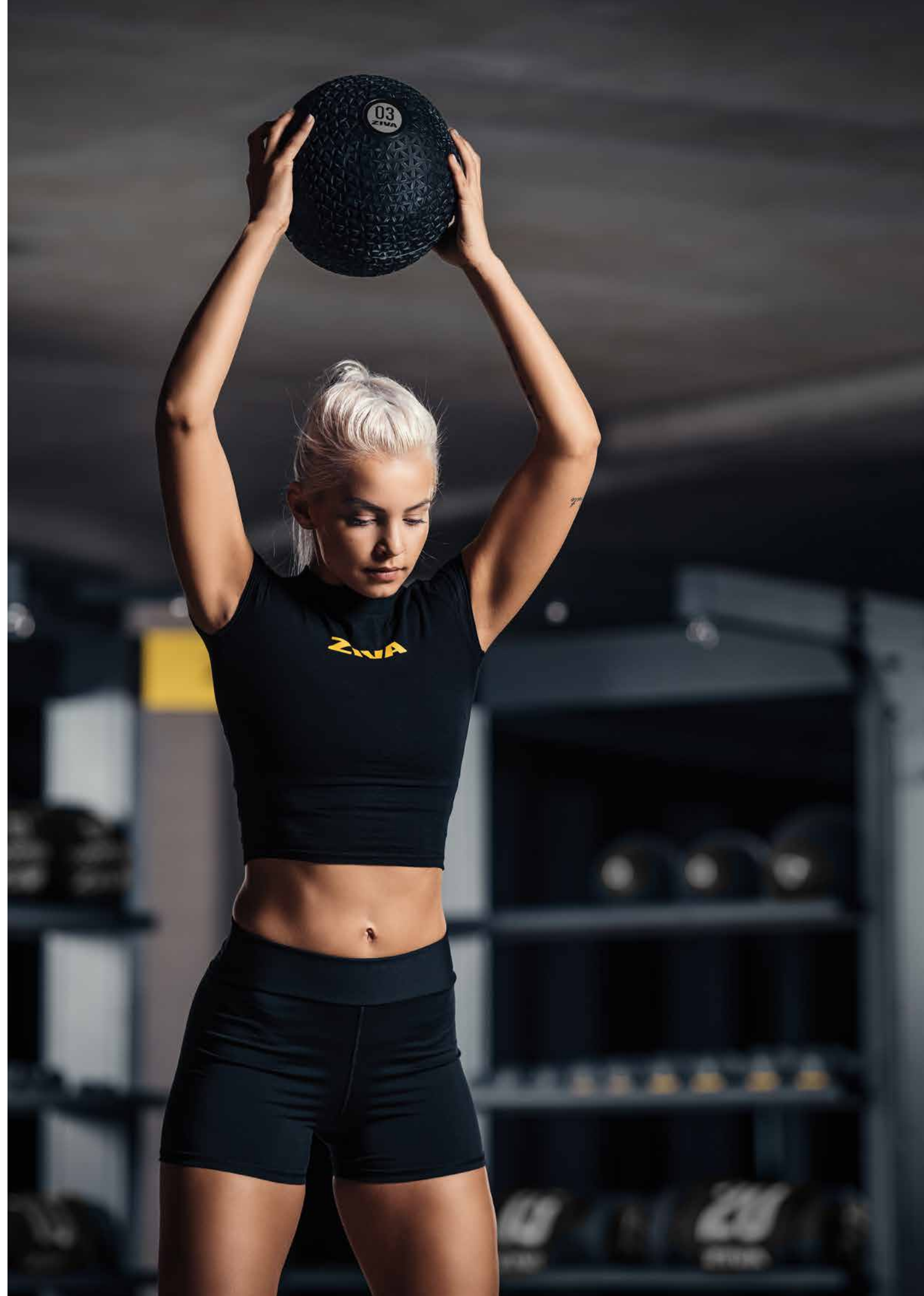

ST 5 MULTI-BALL TREE

The ZIVA® ST 5 Multi-Ball Tree is both a storage solution and a beautiful display for elite-level functional training equipment. Crafted with scratch-resistant black powder coating on tough round steel tubing and 5x shelves, the storage tree perfectly cradles all ball sizes and keeps surrounding spaces uncluttered, giving functional training areas a more premium, higher-end look and feel. The tree comes with the option of chrome-coated or black hardware, allowing for further enhanced gym aesthetics sure to entice visitors.



Order Code
ZST-MDRK-6008

Item Description
ST 5 Multi-Ball Tree

| | | |
|-----------------------|--|---|
| Description | | ST 5 Multi-Ball Tree |
| Specifications | | Made with round steel tubing, welded frames, black or chromed coloured hardware |
| Color Options | | <input checked="" type="checkbox"/> Black powder-coated finish |
| Storage | | Fits up to 5x medicine or slam balls |
| Dimensions | | 56cm x 47cm x 154cm - 13kg |
| Warranty | | Limited 10 year warranty on frames and welding, 1 year on plastic parts |

ST 10 MULTI-BALL TREE

The ZIVA® ST 10 Multi-Ball Tree is an expanded storage solution as well as a beautiful display for elite-level functional training equipment. Crafted with scratch-resistant black powder coating on tough round steel tubing and 10x shelves designed to perfectly cradles all ball sizes and keep surrounding spaces uncluttered, the storage tree gives functional training areas a more premium, higher-end look and feel, and comes with the option of chrome-coated or black hardware, allowing for further enhanced gym aesthetics sure to entice visitors.



Order Code
ZST-MDRK-6009

Item Description
ST 10 Multi-Ball Tree

| | | |
|-----------------------|--|---|
| Description | | ST 10 Multi-Ball Tree |
| Specifications | | Made with round steel tubing, welded frames, black or chromed coloured hardware |
| Color Options | | <input checked="" type="checkbox"/> Black powder-coated finish |
| Storage | | Fits up to 10x medicine or slam balls |
| Dimensions | | 101cm x 51cm x 163cm - 26kg |
| Warranty | | Limited 10 year warranty on frames and welding, 1 year on plastic parts |



WALL BALLS & CORE BAGS

PREMIUM



Use: Functional training areas for elite CrossFit and other high intensity functional training

Ball Casing: Ultra-long-lasting ballistic material

Weight ID & Text: Embroidered

Customer: Big club chains, premium gyms, and top hotels

Warranty: 2 years

MID-RANGE



Use: High intensity functional training areas

Ball Casing: Premium synthetic leather

Weight ID & Text: Embroidered

Customer: CrossFit boxes and high traffic functional fitness facilities

Warranty: 1 year

ENTRY

-

-

ZVO PREMIUM WALL BALL 2.0

The ZVO Premium Wall Ball 2.0 is the absolute pinnacle of durability and design for this seemingly simple full-body strength, coordination, and intense cardio tool. An ultra-long-lasting outer casing made with our newly developed ballistic shell gives the newest version of the Wall Ball a 25% longer lifespan and reinforced stitching guarantees this elite-level equipment will inspire users for years to come. Gym members will push to new levels of performance, practicing a wide range of compound movement to build explosive power alongside cardiovascular endurance and quick reflexes with this stunning functional fitness tool.

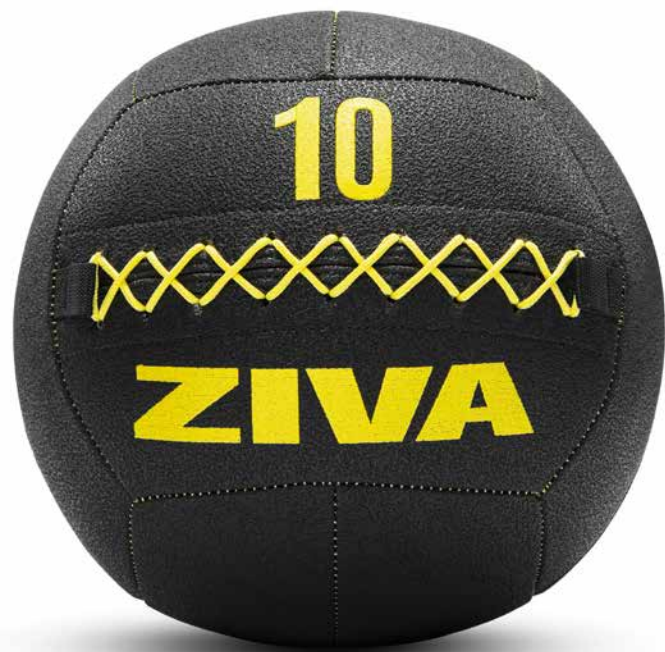

| Order Code | Item Description | Order Code | Item Description |
|---------------|---------------------------------|---------------|----------------------------------|
| ZVO-FTWB-6370 | ZVO Premium Wall Ball 2.0 - 2kg | ZVO-FTWB-6375 | ZVO Premium Wall Ball 2.0 - 7kg |
| ZVO-FTWB-6371 | ZVO Premium Wall Ball 2.0 - 3kg | ZVO-FTWB-6376 | ZVO Premium Wall Ball 2.0 - 8kg |
| ZVO-FTWB-6372 | ZVO Premium Wall Ball 2.0 - 4kg | ZVO-FTWB-6377 | ZVO Premium Wall Ball 2.0 - 9kg |
| ZVO-FTWB-6373 | ZVO Premium Wall Ball 2.0 - 5kg | ZVO-FTWB-6378 | ZVO Premium Wall Ball 2.0 - 10kg |
| ZVO-FTWB-6374 | ZVO Premium Wall Ball 2.0 - 6kg | ZVO-FTWB-6379 | ZVO Premium Wall Ball 2.0 - 12kg |

| | | |
|-----------------------|--|---|
| Description | | ZVO Premium Wall Ball 2.0 |
| Specifications | | Ultra-long-lasting outer casing made from ballistic material and hard-wearing stitching and webbing |
| Color Options | | Black / Yellow Black / Grey |
| Increments | | 1kg increments from 2kg - 10kg and 12kg |
| Warranty | | Limited 2 year warranty |

ZVO PREMIUM POWER CORE BAG 2.0

The ZIVA® ZVO Premium Power Core Bag 2.0 elevates this classic multipurpose functional training tool to elite heights with an ultra-long-lasting newly developed ballistic covering that delivers a 25% longer lifespan for this incredible product. Its incredible usability is further enhanced with its premium quality, high strength stitching and embroidery; heavy-duty nylon straps and ergonomic handles; and air hole end caps that make it safe and silent to smash this bag during intense exercise. This highly flexible functional fitness tool allows for an astounding variety of compound and combined compound lifts favored in the elite training community and will inspire users to reach new highs for years to come.



| Order Code | Item Description | Order Code | Item Description |
|---------------|---|---------------|---|
| ZVO-SPPB-6385 | ZVO Premium Power Core Bag 2.0 - 5kg | ZVO-SPPB-6390 | ZVO Premium Power Core Bag 2.0 - 17.5kg |
| ZVO-SPPB-6386 | ZVO Premium Power Core Bag 2.0 - 7.5kg | ZVO-SPPB-6391 | ZVO Premium Power Core Bag 2.0 - 20kg |
| ZVO-SPPB-6387 | ZVO Premium Power Core Bag 2.0 - 10kg | ZVO-SPPB-6392 | ZVO Premium Power Core Bag 2.0 - 22.5kg |
| ZVO-SPPB-6388 | ZVO Premium Power Core Bag 2.0 - 12.5kg | ZVO-SPPB-6393 | ZVO Premium Power Core Bag 2.0 - 25kg |
| ZVO-SPPB-6389 | ZVO Premium Power Core Bag 2.0 - 15kg | ZVO-SPPB-6394 | ZVO Premium Power Core Bag 2.0 - 30kg |

| | | |
|-----------------------|--|---|
| Description | | ZVO Premium Power Core Bag 2.0 |
| Specifications | | Ultra-long-lasting outer casing made from ballistic material and hard-wearing stitching and webbing |
| Color Options | | Black / Yellow Black / Grey |
| Increments | | 2.5kg increments from 5kg - 2.5kg and 5kg increments from 25kg - 30kg |
| Warranty | | Limited 2 year warranty |



XP WALL BALL PRO

The XP Wall Ball Pro pushes the envelope of durability and design beyond the previously possible. This full-body strength, coordination, and intense cardio tool has been significantly upgraded with a more fully rounded inner core, upping the challenge to users' grips and making training with this tool more directly applicable to ball sports. And the XP Wall Ball Pro has been made even tougher than its predecessor with strengthened stitching along every seam of its premium textured synthetic leather outer casing. This elite-level equipment is sure to inspire and push users to new levels of performance, building explosive power, cardiovascular endurance, and quick reflexes through all the compound movements this tool makes possible.



| Order Code | Item Description | Order Code | Item Description |
|---------------|----------------------|---------------|-----------------------|
| ZVO-FTWB-9651 | XP Wall Ball Pro 3kg | ZVO-FTWB-9656 | XP Wall Ball Pro 8kg |
| ZVO-FTWB-9652 | XP Wall Ball Pro 4kg | ZVO-FTWB-9657 | XP Wall Ball Pro 9kg |
| ZVO-FTWB-9653 | XP Wall Ball Pro 5kg | ZVO-FTWB-9658 | XP Wall Ball Pro 10kg |
| ZVO-FTWB-9654 | XP Wall Ball Pro 6kg | ZVO-FTWB-9659 | XP Wall Ball Pro 12kg |
| ZVO-FTWB-9655 | XP Wall Ball Pro 7kg | | |

| | | |
|-----------------------|--|--|
| Description | | XP Wall Ball Pro |
| Specifications | | Made with premium textured synthetic leather outer casing and hard-wearing stitching |
| Product Color | | Black / Grey |
| Increments | | 1kg increments and 12kg |
| Warranty | | Limited 1 year warranty |

XP POWER CORE BAG PRO

The XP Power Core Bag Pro takes the versatility and power of the classic sandbag and makes it tougher than ever. A thick synthetic leather outer casing with strengthened stitching along every seam means this Bag can take a beating. And with its multiple handles making it ideal for swinging and twisting movements that build up multiple joints and transverse muscles, that toughness comes in handy. This highly flexible tool not only allows users to enjoy a wide variety of compound lifts and combined compound lifts that recruit more stabilizer and torque generating muscles across the entire body, making it a dream for full-body superset routines.



| Order Code | Item Description | Order Code | Item Description |
|---------------|------------------------------|---------------|------------------------------|
| ZXP-SPPB-9471 | XP Power Core Bag Pro 5kg | ZXP-SPPB-9476 | XP Power Core Bag Pro 17.5kg |
| ZXP-SPPB-9472 | XP Power Core Bag Pro 7.5kg | ZXP-SPPB-9477 | XP Power Core Bag Pro 20kg |
| ZXP-SPPB-9473 | XP Power Core Bag Pro 10kg | ZXP-SPPB-9478 | XP Power Core Bag Pro 22.5kg |
| ZXP-SPPB-9474 | XP Power Core Bag Pro 12.5kg | ZXP-SPPB-9479 | XP Power Core Bag Pro 25kg |
| ZXP-SPPB-9475 | XP Power Core Bag Pro 15kg | ZXP-SPPB-9480 | XP Power Core Bag Pro 30kg |

| | | |
|-----------------------|--|--|
| Description | | XP Power Core Bag |
| Specifications | | Made with premium textured synthetic leather outer casing and hard-wearing stitching |
| Product Color | | Black / Grey |
| Increments | | 2.5kg increments and 30kg |
| Warranty | | Limited 1 year warranty |



POWERWAVE BAG

The PowerWave Bag, born from a collaboration with the original creators of the PowerWave, sets a new standard for bag-based workouts. Its distinct, slightly curved design means it cradles perfectly over the back of the neck or across and shoulder and ergonomically placed cushions provide further comfort as well as even weight distribution. Its topside handles make the PowerWave useful as a functional fitness barbell stand-in, while the underside looping strap handles are ideal for swinging rotational movements, or simply as security for when users' grips fail. However the PowerWave is woven into a workout, it pushes functional fitness training sessions to new highs with its versatility and style.



| Order Code | Item Description |
|---------------|--|
| ZMT-PWVE-6180 | PowerWave Apollo 4kg |
| ZMT-PWVE-6181 | PowerWave Super 7kg |
| ZMT-PWVE-6182 | PowerWave Spartan 12kg |
| ZMT-PWVE-6183 | PowerWave Beast 20kg |
| ZMT-PWVE-6190 | PowerWave Group Exercise 15 Pieces Set (12 x 7kg, 3 x 12kg) |
| ZMT-PWVE-6191 | PowerWave Training Exercise 6 Pieces Set (3 x 7kg, 2 x 12kg, 1 x 20kg) |

| | |
|-----------------------|---|
| Description |  PowerWave |
| Specifications |  Made from hard-wearing nylon & PP rope and with a nylon cover, rubber handles and a steel ring |
| Color Options |   Black / Yellow  Black / Grey |
| Warranty |  Limited 1 year warranty |



ST 5-PIECE FUNCTIONAL ACCESSORIES STORAGE RACK

The ZIVA® ST 5-Piece Functional Accessories Storage Rack is equal parts storage and display case. It features 5x cradles that are perfectly suited for storing various sizes of bags or other functional fitness tool and is made from sturdy 3mm thick steel tubing with a scratch- and wear-resistant black powder coat. With long-lasting assembly hardware available in black or chrome, the Functional Accessories Storage Rack is made to match with the overall ZIVA design language.



Order Code
ZST-FTRK-0105

Item Description
ST 5-Piece Functional Accessories Storage Rack

| | | |
|-----------------------|--|--|
| Description | | ST 5-Piece Functional Accessories Storage Rack |
| Specifications | | Made with round steel tubing, welded frames, black or chrome coloured hardware |
| Color Options | | <input checked="" type="checkbox"/> Black powder-coated finish |
| Storage | | Fits up to 5x wall balls or power core bags |
| Dimensions | | 56cm x 47cm x 154cm - 13kg |
| Warranty | | Limited 10 year warranty on frames and welding, 1 year on plastic parts |

ST 10-PIECE FUNCTIONAL ACCESSORIES STORAGE RACK

The ZIVA® ST 10-Piece Functional Accessories Storage Rack is an expanded storage and display case. It features 10x cradles that are perfectly suited for storing various sizes of bags or other functional fitness tool and is made from sturdy 3mm thick steel tubing with a scratch- and wear-resistant black powder coat. With long-lasting assembly hardware available in black or chrome, the Functional Accessories Storage Rack is made to match with the overall ZIVA design language.



Order Code
ZST-FTRK-0210

Item Description
ST 10-Piece Functional Accessories Storage Rack

| | | |
|-----------------------|--|--|
| Description | | ST 10-Piece Functional Accessories Storage Rack |
| Specifications | | Made with round steel tubing, welded frames, black or chrome coloured hardware |
| Color Options | | <input checked="" type="checkbox"/> Black powder-coated finish |
| Storage | | Fits up to 10x wall balls or power core bags |
| Dimensions | | 101cm x 51cm x 163cm - 26kg |
| Warranty | | Limited 10 year warranty on frames and welding, 1 year on plastic parts |

KETTLEBELLS

PREMIUM

SIGNATURE

Use: Functional training areas for elite training and white hot intensity

Coat Material: Black powder

Handle: Black powder finished handle

Customer: Big club chains, premium gyms, and top hotels

Warranty: 3 years

MID-RANGE

SL

Use: Functional training areas for intense training and intense use

Coat Material: Virgin Rubber

Handle: Hard chromed handle

Customer: Big club chains, premium gyms, and top hotels

Warranty: 2 years

ENTRY

PERFORMANCE

Use: Functional Training areas for heavy training and competition

Coat Material: Competition Color Paint

Handle: Chromed handle

Customer: Boutique studios with a functional focus

Warranty: 1 years

SIGNATURE STEEL COMPETITION KETTLEBELLS BY STEVE COTTER

The ZIVA® Signature Steel Competition Kettlebells by Steve Cotter are the pinnacle of quality and design for this foundational functional fitness tool. Created with the expert input of kettlebell pioneer Steve Cotter, these kettlebells are made to be absolutely unbreakable. They feature a crack-, corrosion-, and scratch-resistant black powder coating and vibrant yellow, easy ID numbering, and come with a full steel handle and bell that elevate them beyond mere exercise equipment to the level of functional sculpture, something with which users will be proud to sculpt their bodies.

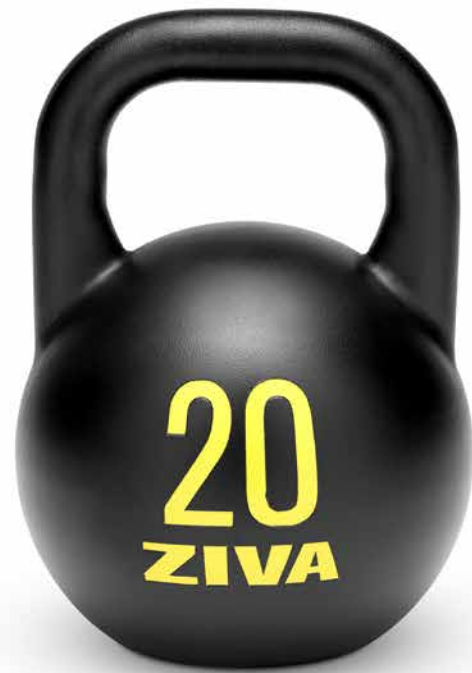

| Order Code | Item Description | Order Code | Item Description |
|------------------|---|------------------|---|
| ZMT-CTKB-5659-BK | Signature Steel Competition Kettlebell 4kg | ZMT-CTKB-5627-BK | Signature Steel Competition Kettlebell 22kg |
| ZMT-CTKB-5660-BK | Signature Steel Competition Kettlebell 6kg | ZMT-CTKB-5628-BK | Signature Steel Competition Kettlebell 24kg |
| ZMT-CTKB-5620-BK | Signature Steel Competition Kettlebell 8kg | ZMT-CTKB-5629-BK | Signature Steel Competition Kettlebell 26kg |
| ZMT-CTKB-5621-BK | Signature Steel Competition Kettlebell 10kg | ZMT-CTKB-5630-BK | Signature Steel Competition Kettlebell 28kg |
| ZMT-CTKB-5622-BK | Signature Steel Competition Kettlebell 12kg | ZMT-CTKB-5631-BK | Signature Steel Competition Kettlebell 30kg |
| ZMT-CTKB-5623-BK | Signature Steel Competition Kettlebell 14kg | ZMT-CTKB-5633-BK | Signature Steel Competition Kettlebell 32kg |
| ZMT-CTKB-5624-BK | Signature Steel Competition Kettlebell 16kg | ZMT-CTKB-5634-BK | Signature Steel Competition Kettlebell 34kg |
| ZMT-CTKB-5625-BK | Signature Steel Competition Kettlebell 18kg | ZMT-CTKB-5637-BK | Signature Steel Competition Kettlebell 36kg |
| ZMT-CTKB-5626-BK | Signature Steel Competition Kettlebell 20kg | | |

| | | |
|----------------------|----------------------------------|--|
| Description | | Signature Steel Competition Kettlebells by Steve Cotter |
| Coating | | Steel bell and handle, with hard-wearing crack-resistant powder surface coating |
| Color Options | Black / Yellow Black / Grey | |
| Increments | | 2kg increments from 4kg - 36kg |
| Handle | | 34mm steel handle with super textured powder coating to stop slippage during use |
| Warranty | | Limited 3 year warranty |

EX KETTLEBELL RACK 2.0

The ZIVA EX Kettlebell Rack 2.0 holds up to 10x kettlebells on its PVC-lined and -edged shelves, making it a storage space that both protects and shows them off. This Rack is built tough with a solid steel, heavy-duty frame crafted from plate steel and steel tubing that have a scratch- and corrosion-resistant black powder-coat finish, and its grey accent panels can be customized with any Pantone color. Protective foot pads keep floors pristine while handsome chrome hardware allows for bolting in place, but with the Rack's impressive 55kg heft, not including the kettlebells' weight, this is hardly necessary.



| Order Code | Item Description |
|---------------|------------------------|
| ZEX-KB05-7316 | EX Kettlebell Rack 2.0 |

| | | |
|-----------------------|---|---|
| Description | | EX Kettlebell Rack 2.0 |
| Specifications | | Made with solid steel frame, welded, black panels and chrome colored hardware |
| Product Color | Metallic black powder-coated finish with black panels | |
| Storage | | Fits up to 10 x kettle bells |
| Dimensions | | 125cm x 75cm x 55cm - 55kg |
| Warranty | | Limited 10 year warranty on frames and welding, 1 year on plastic parts |



SL VIRGIN RUBBER KETTLEBELLS

The ZIVA® SL Virgin Rubber Kettlebells use long-lasting wear-, water-, and corrosion-resistant virgin rubber coating that falls more quietly, with more bounce and less impact than its counterparts, so it won't damage surroundings even during the most intense HIIT workouts. Its ultra-durable chrome grip is naturally more protected against dings and scratches than cast iron or plastic and serves a bold, iconic style that makes them gym centerpieces worthy of display.

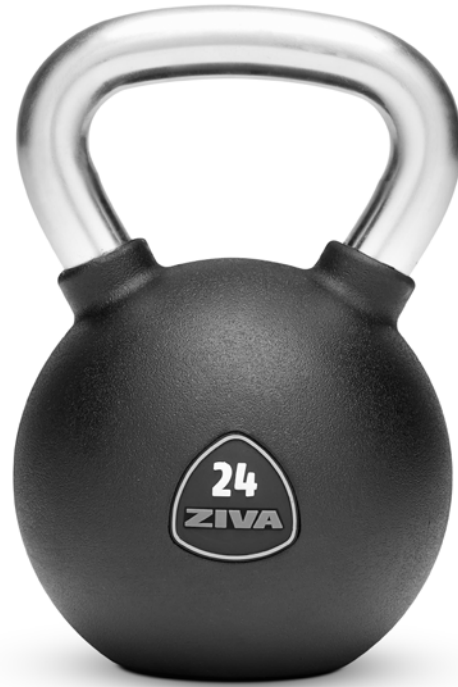

| Order Code | Item Description | Order Code | Item Description |
|---------------|----------------------------------|---------------|----------------------------------|
| ZSL-RBKB-4320 | SL Virgin Rubber Kettlebell 4kg | ZSL-RBKB-4327 | SL Virgin Rubber Kettlebell 20kg |
| ZSL-RBKB-4321 | SL Virgin Rubber Kettlebell 6kg | ZSL-RBKB-4328 | SL Virgin Rubber Kettlebell 24kg |
| ZSL-RBKB-4322 | SL Virgin Rubber Kettlebell 8kg | ZSL-RBKB-4329 | SL Virgin Rubber Kettlebell 28kg |
| ZSL-RBKB-4323 | SL Virgin Rubber Kettlebell 10kg | ZSL-RBKB-4330 | SL Virgin Rubber Kettlebell 32kg |
| ZSL-RBKB-4324 | SL Virgin Rubber Kettlebell 12kg | ZSL-RBKB-4331 | SL Virgin Rubber Kettlebell 36kg |
| ZSL-RBKB-4325 | SL Virgin Rubber Kettlebell 14kg | ZSL-RBKB-4332 | SL Virgin Rubber Kettlebell 40kg |
| ZSL-RBKB-4326 | SL Virgin Rubber Kettlebell 16kg | | |

| | | |
|----------------------|--|---|
| Description | | SL Virgin Rubber Kettlebell |
| Coating | | Solid precision casting, premium rubber surface coating |
| Color Options | | Black / Grey / White |
| Increments | | 2kg increments from 4kg - 36kg |
| Handle | | Hard chromed handle |
| Warranty | | Limited 2 year warranty |

ST KETTLEBELL RACK

The ZIVA® ST Kettlebell Rack is equal parts display case and storage piece. Designed to have a minimal footprint yet provide ample storage space, it fits up to 10x kettlebells on its thick steel, PVC-lined and -edged shelves. The Rack's solid steel construction features scratch-, rust-, and wear-resistant black powder coating and floor-protecting foot covers, and can be bolted down with chrome hardware if desired, but its 50kg heft is often secure enough.



| Order Code | Item Description |
|---------------|--------------------|
| ZST-KBRK-5395 | ST Kettlebell Rack |





| | | |
|-----------------------|--|---|
| Description | | ST Kettlebell Rack |
| Specifications | | Made with commercial grade 89mm steel tubing, welded base. Thick steel shelves with PVC mats and edging to protect the kettle bells. Chromed hardware |
| Color Options | | Black powder-coated finish |
| Storage | | Fits up to 10x kettle bells |
| Dimensions | | 111cm x 81.5cm x 66.5cm - 50kg |
| Warranty | | Limited 10 year warranty on frames and welding, 1 year on plastic parts |

SL TYRE X

ZIVA® SL TYRE X takes an increasingly popular functional strength training tool and enhances its usability, storability, and durability. Available in a variety of sizes to challenge users at a variety of strength levels, the TYRE X features a hard-wearing, reinforced PVC skin, reinforced PP/Nylon strap handles on each of its 10x sides and around its center, and a no-roll design that keeps it under control whether stored away or used as part of an intense workout. The SL TYRE X serves as a signal to functional fitness enthusiasts that a gym is at the forefront of the latest exercise trends.



| Order Code | Item Description |
|---------------|---------------------|
| ZSL-TYVR-4127 | SL TYRE X 40kg |
| ZSL-TYVR-4128 | SL TYRE X 60kg |
| ZSL-TYVR-4129 | SL TYRE X 80kg |
| ZSL-TYVR-4139 | SL TYRE X 10kg Pump |





| | |
|-----------------------|---|
| Description |  SL TYRE X |
| Specifications |  Long-lasting reinforced PVC cover and reinforced gripping handles with a internal PU foam structure to give added user protection |
| Color Options |  Black / Yellow / White |
| Warranty |  Limited 1 year warranty |

ZVO GLUTE PLYO BOX

While usable as a regular plyo box, the ZIVA® ZVO Glute Plyo Box is specially designed to emphasize glute and calf activation in a way that's impossible with the average, flat-topped box. The Glute Plyo Box's sloping surface, covered in a high-durability PVC coat, forces users' feet, ankles, and legs into the optimal positions to most accurately target tough to hit body parts so trainers can ensure the best results in the areas that matter most to users.



| Order Code | Item Description |
|---------------|--------------------|
| ZMT-GLPY-5671 | ZVO Glute Plyo Box |

| | |
|-----------------------|--|
| Description |  ZVO Glute Plyo Box |
| Specifications |  Inner core is made with a PE Foam core and PU foam outer shell. The outside is made from hard-wearing PVC shell with webbing handles |
| Color Options |  Black / Yellow |
| Dimensions |  75 x 75 base with sloping top |
| Warranty |  Limited 1 year warranty |



ZIVA

30"
75 cm

20"
51 cm

24"
61 cm

61 cm

80 KG

ZIVA

ZIVA

03

ZIVA

SL 3-IN-1 PLYO BOX WITH INNER PU FOAM

High-intensity high jumps, cardio building low step ups, and a happy medium that builds both strength and stamina, all with low risk, low impact, and superior stability in a single piece of equipment. That's the SL 3-in-1 Plyo Box. This Plyo Box offers 3 different intensities. Turn it one way, and it's a tough 20-in. step platform. Turn it another, and it's a high-intensity jump workout tool. Give it one more turn to 30-in. and it's a workout that builds speed, explosivity, and power. Any way you turn it, it's a functional fitness mainstay. And despite its easy-on-joints softness, this Box is built tough with underlying wooden platforms on top of a PU foam core, all wrapped in commercial-grade, high-durability anti-slip PVC skin.



Order Code
ZSL-SFPY-4013

Item Description
SL Soft 3-in-1 Plyo Box with PU Foam (51cm x 61cm x 75cm)

| | | |
|-----------------------|--|---|
| Description | | SL Soft 3-in-1 Plyo Box with PU Foam |
| Specifications | | Made with a solid PU foam inner core, inner wooden platforms and with a PVC outer coating |
| Color Options | | Black / White |
| Warranty | | Limited 1 year warranty |



ZVO DUAL SURFACE PLYO BOX 3-PIECE SET

The ZVO Dual Surface Plyo Box 3-Piece Set delivers hard-wearing versatility that stacks and stores, lifting functional fitness to ever higher performance. Each of the 3 differently sized boxes feature a firm side that acts as a steady landing platform at any height and a soft side that challenges users' ankle, knee, and hip stabilizers for incomparable functional fitness workouts. Sturdy velcro straps keep them stable no matter how high they are stacked and a tough PVC skin gives them a long life even with heavy use in high-traffic commercial gyms.



Order Code
ZFT-PYST-0738

Item Description
ZVO Dual Surface Plyo Box 3 Piece Set - 15, 30, and 45cm (6", 12", and 18" inches) New Velcro Strap

| | | |
|-----------------------|--|--|
| Description | | ZVO Dual Surface Plyo Box 3 Piece Set |
| Specifications | | Made with a solid PE foam inner core, with solid PU foam edging, with hard wearing PVC outer coating |
| Color Options | | Black / Grey / Yellow |
| Warranty | | Limited 1 year warranty |

ZVO DUAL SURFACE PLYO BOX 4-PIECE SET

The ZVO Dual Surface Plyo Box 4-Piece Set delivers hard-wearing versatility that stacks and stores to new heights of functional fitness performance. Each of the 4 differently sized boxes feature a firm side that acts as a steady landing platform at any height and a soft side that challenges users' ankle, knee, and hip stabilizers for incomparable functional fitness workouts. Sturdy velcro straps keep them stable no matter how high they are stacked and a tough PVC skin gives them a long life even with heavy use in high-traffic commercial gyms.



Order Code
ZFT-PYST-0739

Item Description
ZVO Dual Surface Plyo Box 4 Piece set - 15, 30, 45 and 60cm (6", 12", 18" and 24" inches) New Velcro Strap

| | | |
|-----------------------|--|--|
| Description | | ZVO Dual Surface Plyo Box 4 Piece Set |
| Specifications | | Made with a solid PE foam inner core, with solid PU foam edging, with hard-wearing PVC outer coating |
| Color Options | | Black / Grey / Yellow |
| Warranty | | Limited 1 year warranty |



XP POWER SLED 2.0

The ZIVA® XP Power Sled 2.0 pushes functional fitness further. The Power Sled delivers full-body strength and cardio gains in a single, rugged package that features poles for easy pushing from a variety of heights on one side and a sturdy bar made for pulling on the other. Its central pillar can be stacked with a tremendous amount of weight, and its entire structure is coated in a scratch- and corrosion-resistant finish, creating a functional fitness centerpiece guaranteed to last. The Sled is crafted from 3mm thick steel and by itself weighs in at a hefty 39kg but can be stacked with as much weight as needed.



Order Code
ZXP-PWSD-4019

Item Description
XP Power Sled 2.0

| | | |
|-----------------------|--|---|
| Description | | XP Power Sled 2.0 |
| Specifications | | Made with commercial-grade steel tubing and plate steel and high tensile hardware. Includes harness |
| Color Options | | Charcoal powder-coated finish |
| Dimensions | | 101cm x 61cm - 39kg |
| Warranty | | Limited 10 year warranty on frames and welding, 1 year on plastic parts |

ZEL SIGNATURE BATTLE ROPES

The ZIVA® Signature Battle Rope, designed in association with legendary strongman John Brookfield, is the absolute pinnacle of elite functional fitness training tools. Available in a variety of lengths and weights, and woven from an ultra-long-lasting PP/nylon mix, the Signature Battle Rope features slick rubber handles that build users' grip strength and also include patented built-in wrist straps so they can keep going even after their grip fails. The Signature Series represents the Everest of high quality and design, and is engineered to inspire new levels of intensity and passion.



Order Code
ZMT-BTRP-5610
ZMT-BTRP-5611
ZMT-BTRP-5612
ZMT-BTRP-5613

Item Description
Signature Battle Rope (5cm x 15.24m) / (2.0" x 50') 16kg
Signature Battle Rope (3.8cm x 10m) / (1.5" x 33') 8kg
Signature Battle Rope (3.8cm x 15.24m) / (1.5" x 50') 12kg
Signature Battle Rope (5.0cm x 10m) / (2.0" x 33') 10.6kg





| | | |
|-----------------------|--|--|
| Description | | Signature Battle Rope |
| Specifications | | PP and nylon intertwined rope with rubber handles, steel securing ring and patented wrist straps |
| Product Color | | Black / Yellow |
| Warranty | | Limited 1 year warranty |

ZVO ANTI-BURST CORE-FIT BALLS

The right tools with the right design and the right materials can easily elevate training to new levels. The ZVO Anti-Burst Core Fit Ball is one such elevation. Designed with a non-slip, easy to grip surface and made with BPA-free PVC, the ZVO Anti-Burst Core Fit Ball comes in different sizes for different body types, but all are tested up to 880 lb (400kg) so workout sessions stays safe no matter how intense. Added to any weight-focused workout, it challenges users by recruiting more stabilizer muscles. As the centerpiece of any core workout, it maximizes muscle-building across the entire abdominal wall, easily and efficiently targeting the abs, obliques, and erectors.



| Order Code | Item Description |
|---------------|---|
| ZVO-ABCB-9291 | ZVO 55 cm Anti-Burst Core-Fit Ball (10 Pieces Per Pack) |
| ZVO-ABCB-9270 | ZVO 65 cm Anti-Burst Core-Fit Ball (10 Pieces Per Pack) |
| ZVO-ABCB-9292 | ZVO 75 cm Anti-Burst Core-Fit Ball (10 Pieces Per Pack) |





| | | |
|-----------------------|---|--|
| Description |  | ZVO Anti-Burst Core-Fit Ball |
| Specifications |  | Made with heavy-duty and durable PVC |
| Color Options |  |  Black / Yellow |
| Warranty |  | Limited 1 year warranty |

ZVO ANTI-BURST CORE-FIT BALL COVER

The right tools with the right design and the right materials can still be made even better. The ZVO Anti-Burst Core Fit Ball PU Leather Cover is how you do it. Even less slip, even more grip, and adding a whole new layer of unbreachable toughness, the Anti-Burst Core Fit Ball PU Leather Cover comes in different sizes to match different sized balls and elevates the Ball's aesthetic to a new level of luxurious.



| Order Code | Item Description |
|---------------|--|
| ZVO-ABFC-2355 | ZVO 55 cm Anti-Burst Core-Fit Ball Cover |
| ZVO-ABFC-2356 | ZVO 65 cm Anti-Burst Core-Fit Ball Cover |
| ZVO-ABFC-2357 | ZVO 75 cm Anti-Burst Core-Fit Ball Cover |

| | | |
|-----------------------|---|--|
| Description |  | ZVO Anti-Burst Core-Fit Ball Cover |
| Specifications |  | Made with premium textured PU leather outer casing and hard-wearing stitching |
| Product Color |  |  Brown / Grey |
| Warranty |  | Limited 1 year warranty |





CORE-FIT BALL STORAGE RACK

Core Fit Balls are an integral part of any core training or functional fitness workout but they can be tough to safely store. No longer. The ZIVA® Core Fit Ball Storage Rack, crafted from black powder coated steel tubing, not only keeps up to 3x Core Fit Balls organized exactly where they are needed, but displays them with a modern, minimalist look.



Order Code
ZST-EXBS-0074

Item Description
Core Fit Ball Storage Rack

| | | |
|-----------------------|---|---|
| Description |  | Core Fit Ball Storage Rack |
| Specifications |  | Made with commercial grade tubing |
| Color Options |  | <input checked="" type="checkbox"/> Charcoal powder-coated finish |
| Warranty |  | Limited 1 year warranty |









TPE DELUXE YOGA MAT

The ZIVA® TPE Deluxe Yoga Mat is the premiere choice for floor-based exercise functionality and stores easily to facilitate faster setup for group classes. Available with a choice of thicknesses, the Deluxe Yoga Mat gives users a comfy cushion while preventing slippage of hands and feet thanks to wavy textured surface, while the mat stays secure with its high traction textured bottom. A cutting-edge closed-cell formulation prevents absorption of liquid, and eyelets allow for easy wall storage when combined with the ZIVA® Studio Mat Rack.



| Order Code | Item Description |
|---------------|--|
| ZSL-TDYM-0250 | TPE Deluxe Yoga Mat 125cm x 61cm x 14mm (10 Pieces Per Pack) |
| ZSL-TDYM-0251 | TPE Deluxe Yoga Mat 165cm x 61cm x 10mm (10 Pieces Per Pack) |
| ZVO-MTRK-0200 | Studio Mat Rack |





| | | |
|-----------------------|---|---|
| Description |  | TPE Deluxe Yoga Mat |
| Specifications |  | Latex-free TPE foam, patterned surface provides secure traction, closed cell construction prevents absorption of liquids, eyelets for easy storage and 10mm or 14mm thickness; Studio Mat Rack - Peg length 210mm |
| Color Options |  |  Black / Grey |
| Warranty |  | Limited 1 year warranty |

STUDIO NBR MAT

The 15mm thick ZIVA® Studio NBR Mat is a well-cushioned cloud of comfort that provides a soft, airy cradle for users during any floor-based exercises. Perfect for use on the often textured floors of functional fitness areas, these mats feature easy to clean hygienic surfaces and eyelets for easy, out of the way storage. Available in stylish black, the Studio NBR Mat uses the same ZIVA design language that make all our products aesthetic wonders.



| Order Code | Item Description |
|---------------|---|
| ZSL-NPSM-0204 | Studio NBR Mat 165cm x 61cm x 15mm (10 Pieces Per Pack) |

| | | |
|-----------------------|---|--|
| Description |  | Studio NBR Mat |
| Specifications |  | Thick cushioned NBR (Studio Mat) with a soft airy feel, easy to clean hygienic surface and 15mm thickness <i>Not suitable for polished surfaces</i> |
| Color Options |  |  Black |
| Warranty |  | Limited 1 year warranty |





XP BALANCE BALL

The ZIVA® XP Balance Ball is the pinnacle of design and quality when it comes to challenging users balance and building their stabilizer muscles. Crafted with long-lasting, durable PVC for the ball surface and tough PP platform and edging on bottom, this Balance Ball provides premium, commercial-grade traditional functional training tool that enables low-impact, stress-reducing exercises to strengthen core and stabilizer muscles so users' maintain a healthy balance throughout their musculoskeletal system. In grey and black, it brings an understated aesthetic made to match ZIVA design language.



Order Code
ZXP-BUBL-0564

Item Description
XP Balance Ball

| | | |
|-----------------------|---|--|
| Description |  | XP Balance Ball |
| Specifications |  | Made with hard-wearing PVC bladder and PP edging |
| Color Options |  |  Black / Grey |
| Warranty |  | Limited 1 year warranty |



ZIVA



PRO FT STEP

The ZIVA® Pro FT Step takes the tried and true aerobic step and elevates it with a hard-wearing, non-slip PP landing pad and aesthetically advanced ZIVA design language that gives its surroundings an immediate premium look and feel. The Pro FT Step is a must-have in any functional fitness area and makes delivery of calisthenic, aerobic, and other group classes simple and scalable, as its multi-height stackability allows users to set their own pace with minimal expert instruction needed.



Order Code
ZFT-FTSP-0593

Item Description
Pro FT Step

| | | |
|-----------------------|--|--|
| Description | | Pro FT Step |
| Specifications | | Hard-wearing PP casing, non-slip landing pad, multi-height and stackable |
| Color Options | | Black / Yellow Black / Grey |
| Warranty | | Limited 1 year warranty |

STUDIO

Every piece is made to facilitate as wide a range of functional exercises as possible but have been designed with slim profiles and small footprints to allow for maximally efficient use of floorspace.



The image features a collection of ZIVA Performance Series gym equipment. In the foreground, two black hexagonal dumbbells with silver handles are prominently displayed. Each dumbbell has the number '15' and the 'ZIVA' logo printed in white on its end. In the background, a black resistance band with a white 'ZIVA' logo is visible, along with another dumbbell. The equipment is set against a light-colored, textured background, possibly a gym floor or mat.

In this category, we've crafted a collection uniquely tailored to the needs of dynamic boutique gyms and training studios. To meet their needs, we have created storage solutions that stash more equipment in less space while still looking great. We have designed equipment that focuses on functional fitness and other highly sought after workout styles and have built mobility into storage pieces to make it easier to train more clients in less time.

Our commitment to small businesses in the fitness industry is what lies at the heart of the ZIVA® Performance Series. It is exemplified in all this equipment but particularly the Performance PLUS 4-Tier Storage Rack. This easily movable shelving unit is able to pack everything trainers might need to give clients a complete functional fitness workout, and because it can be moved so easily throughout gyms of any size, it allows them to shuttle seamlessly from one area, one exercise, and one client to the next so they can do more, faster, with less effort.

PERFORMANCE RPU HEXAGON DUMBBELL

Dumbbells offer a sleek, eye-catching and longer-lasting alternative to the shabby, steel-grey iron chunks of yesteryear. These dumbbells feature cutting-edge RPU coatings over the dumbbells' heads, giving them a textured feel, a vibrant look, and a scratch- and scuff-resistant, long-lasting life. Their straight handles are fully knurled and come with a rust- and scratch-proof chrome coat. They have a modern aesthetic and no-roll design. In a word, they are a shining example of always reliable, world-class ZIVA quality.



| Order Code | Item Description | Order Code | Item Description |
|--------------------|---|--------------------|---|
| ZFT-DBUX-5140-BKGY | Performance RPU Hexagon Dumbbell 2.5kg | ZFT-DBUX-5148-BKGY | Performance RPU Hexagon Dumbbell 22.5kg |
| ZFT-DBUX-5141-BKGY | Performance RPU Hexagon Dumbbell 5kg | ZFT-DBUX-5149-BKGY | Performance RPU Hexagon Dumbbell 25kg |
| ZFT-DBUX-5142-BKGY | Performance RPU Hexagon Dumbbell 7.5kg | ZFT-DBUX-5150-BKGY | Performance RPU Hexagon Dumbbell 27.5kg |
| ZFT-DBUX-5143-BKGY | Performance RPU Hexagon Dumbbell 10kg | ZFT-DBUX-5151-BKGY | Performance RPU Hexagon Dumbbell 30kg |
| ZFT-DBUX-5144-BKGY | Performance RPU Hexagon Dumbbell 12.5kg | ZFT-DBUX-5204-BKGY | Performance RPU Hexagon Dumbbell 32.5kg |
| ZFT-DBUX-5145-BKGY | Performance RPU Hexagon Dumbbell 15kg | ZFT-DBUX-5205-BKGY | Performance RPU Hexagon Dumbbell 35kg |
| ZFT-DBUX-5146-BKGY | Performance RPU Hexagon Dumbbell 17.5kg | ZFT-DBUX-5206-BKGY | Performance RPU Hexagon Dumbbell 37.5kg |
| ZFT-DBUX-5147-BKGY | Performance RPU Hexagon Dumbbell 20kg | ZFT-DBUX-5207-BKGY | Performance RPU Hexagon Dumbbell 40kg |

| | | |
|-----------------------|--|---|
| Description | | Performance RPU Hexagon Dumbbell |
| Specifications | | Unique patented design made with premium rubberized polyurethane outer casing with steel heads and chrome handles |
| Handle | | Premium chrome handle |
| Color Options | | Black / Grey / White |
| Increments | | 2.5kg increments |
| Warranty | | Limited 2 year warranty |

PERFORMANCE 2-TIER, 10-PAIR HEXAGON DUMBBELL RACK

The perfect size and functionality of our sturdy, heavy-gauge steel 8-pair Dumbbell Rack is extended to hold a total of up to 10x pairs of dumbbells so users are guaranteed even faster, easier access to more of the tools they need for any intense core, HIIT, and resistance training workouts. The Rack's shelves are ergonomically angled for the safest, easiest pick up/put down. Designed to match ZIVA aesthetics and our Hexagon Dumbbells, this rack gives always fast access to equipment while delivering an elite-level look and intuitive organization.



| Order Code | Item Description |
|---------------|---|
| ZFT-DBST-5353 | Performance 2-Tier, 10-pair Hexagon Dumbbell Rack |

| | | |
|-----------------------|--|---|
| Description | | Performance 2-Tier, 10-Pair Hexagon Dumbbell Rack |
| Specifications | | Made with oval steel tubing 2mm thick, thick plate steel, welded frames, black- or chrome-colored hardware and PVC shelf lining |
| Product Color | | Black powder-coated finish |
| Storage | | Fits Up to 10-Pairs of hexagon dumbbells |
| Dimensions | | 180cm x 61cm x 82cm - 38kg |
| Warranty | | Limited 5 year warranty on frames and welding, 1 year on plastic parts |

PERFORMANCE 3-TIER, 10-PAIR HEXAGON DUMBBELL RACK

The 3-Tier, 10-Pair Dumbbell Rack packs up to 10x pairs of dumbbells into a smaller footprint rack so users are guaranteed even quicker, easier access to even more of the tools they need for any intense core, HIIT, and resistance training workouts. The Rack's shelves are ergonomically angled to allow the safest, easiest pick up/put down and its sturdy, heavy-gauge steel construction gives it an unparalleled service life. Designed to match ZIVA® aesthetics and our hexagon dumbbells, this rack gives always fast access to equipment while delivering a elite-level look and intuitive organization.



Order Code
ZFT-DBST-5124

Item Description
Performance 3-Tier, 10-pair Hexagon Dumbbell Rack

| | | |
|-----------------------|--|---|
| Description | | Performance Hexagon Dumbbell Rack |
| Specifications | | Made with oval steel tubing 2mm thick, thick plate steel, welded frames, black- or chrome-colored hardware and PVC shelf lining |
| Product Color | | Black powder-coated finish |
| Storage | | Fits up to 10-pairs of SL Urethane or Performance Hexagon Dumbbells |
| Dimensions | | 100cm x 61cm x 99cm - 36kg |
| Warranty | | Limited 5 year warranty on frames and welding, 1 year on plastic parts |

PERFORMANCE 3-TIER, 10-PAIR ROUND DUMBBELL RACK WITH SADDLES

The ZIVA® Performance 3-Tier, 10-Pair Rack with Saddles features curved weight cradles to fit up to 10x pairs of our Performance Virgin Rubber Dumbbells with a smaller footprint. The dumbbells, with their classic design and durable rubber-coated steel heads, nestle perfectly into the Rack's sturdy PVC saddles. Its sturdy steel gauge piping gives it an unparalleled service life while its feet pads keep gym floors scuff-free. The shelves are ergonomically angled for safe and easy racking and unracking and shelves serve as both storage and display that delivers a premium aesthetic.



Order Code
ZFT-DBST-5969

Item Description
Performance 3-Tier, 10-Pair Round Dumbbell Rack with Saddles

| | | |
|-----------------------|--|--|
| Description | | Performance 3-Tier, 10-Pair Round Dumbbell Rack with Saddles |
| Specifications | | Made with oval steel tubing 2mm thick, thick plate steel, welded frames, black- or chrome-colored hardware and saddles |
| Product Color | | Black powder-coated finish |
| Storage | | Fits 10-pairs of round head dumbbells |
| Dimensions | | 145cm x 61cm x 104cm - 59kg |
| Warranty | | Limited 5 year warranty on frames and welding, 1 year on plastic parts |



NEOPRENE TRIBELLS

The ZIVA® Neoprene Tribell is a workout essential for resistance-enhanced calisthenics and HIIT training. They feature a textured, non-slip, durable neoprene finish that sticks in the hand, making them particularly well suited for use with beginners. These Tribells' precision-calibrated weights are evenly distributed across their structure so hands never develop sore spots even as muscles fatigue. Their always reliable ZIVA® commercial-quality guarantee they will endure workouts for years to come.



| Order Code | Item Description | Order Code | Item Description |
|--------------------|-------------------------|--------------------|-----------------------|
| ZFT-NPHX-6580-BKGY | Neoprene Dumbbell 0.5kg | ZFT-NPHX-6583-BKGY | Neoprene Dumbbell 3kg |
| ZFT-NPHX-6581-BKGY | Neoprene Dumbbell 1kg | ZFT-NPHX-6584-BKGY | Neoprene Dumbbell 4kg |
| ZFT-VNHX-5849-BKGY | Neoprene Dumbbell 1.5kg | ZFT-NPHX-6585-BKGY | Neoprene Dumbbell 5kg |
| ZFT-NPHX-6582-BKGY | Neoprene Dumbbell 2kg | | |

| | | |
|-----------------------|--|--|
| Description | | Neoprene Dumbbells |
| Specifications | | Neoprene surface coating and fits with ZST-DBST-1835-BK ST 20-Pair 1-10kg Studio Dumbbell Rack |
| Color Options | | Black / Grey / White |
| Increments | | 0.5kg increments from 0.5-2kg and 1kg increments from 2-5kg |
| Warranty | | Limited 2 year warranty |

1-10KG STUDIO DUMBBELL RACK

The ZIVA® 1-10KG Studio Dumbbell Rack, made with 75 x 75mm steel tubing, plate steel, and padded saddles, keeps lighter dumbbells well organized and well displayed for a decluttered floor space. Made specifically to withstand the rigors of the high-traffic commercial gym environment, this rack features scratch-, rust-, and wear-resistant black powder coating that keeps it looking newer for longer no matter how busy things may get.

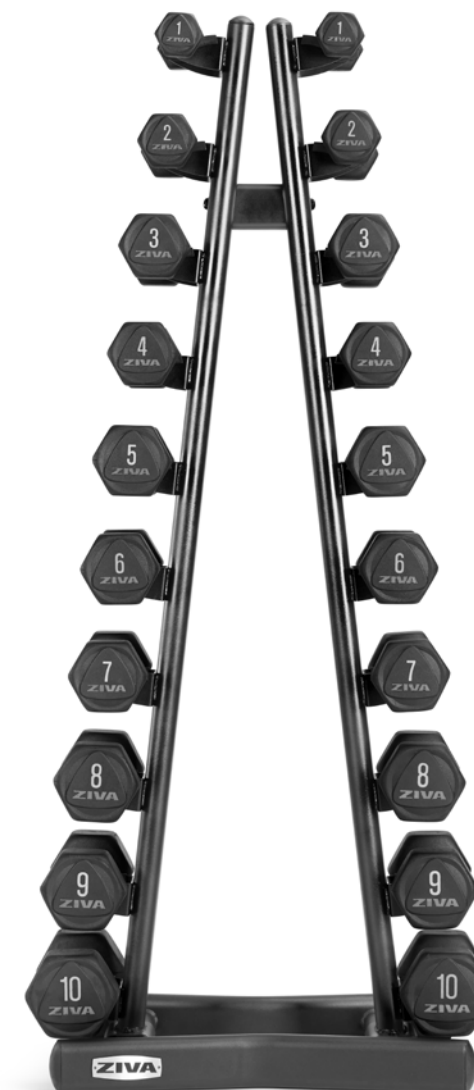

| Order Code | Item Description |
|---------------|-----------------------------|
| ZFT-VS10-5136 | 1-10kg Studio Dumbbell Rack |

| | | |
|-----------------------|--|---|
| Description | | 1-10kg Studio Dumbbell Rack |
| Specifications | | Made with 75mm x 75mm tubing, vertical style frame with PU cushions on steel saddles. Fits 1-10kg dumbbells |
| Color Options | | Black powder-coated finish |
| Storage | | Fits 10-Pairs of dumbbells, hexagons, tribells or neoprene tribells |
| Dimensions | | 96cm x 86cm x 121cm - 56kg |
| Warranty | | Limited 10 year warranty on frames and welding, 1 year on plastic parts |

PERFORMANCE COMPETITION KETTLEBELL

The kettlebell is a beautifully simple, full-body strength-building and conditioning tool. ZIVA® Performance Competition Kettlebells take this conventionally unadorned iron ball and add an eye-catching splash of competition color. With rust- and corrosion-resistant paint in pink, blue, yellow, purple, green, orange, and red, its ultra-durable chrome handle helps build grip strength and is less prone to dings and scratches than cast iron or plastic. These iconic, boldly styled kettlebells are gym centerpieces worthy display, and even more worthy of great competition.



| Order Code | Item Description | Order Code | Item Description |
|---------------|---|---------------|---|
| ZFT-CTKB-6643 | Performance Competition Kettlebell 8kg | ZFT-CTKB-6647 | Performance Competition Kettlebell 20kg |
| ZFT-CTKB-6644 | Performance Competition Kettlebell 10kg | ZFT-CTKB-6648 | Performance Competition Kettlebell 24kg |
| ZFT-CTKB-6645 | Performance Competition Kettlebell 12kg | ZFT-CTKB-6649 | Performance Competition Kettlebell 28kg |
| ZFT-CTKB-6667 | Performance Competition Kettlebell 14kg | ZFT-CTKB-6650 | Performance Competition Kettlebell 32kg |
| ZFT-CTKB-6646 | Performance Competition Kettlebell 16kg | | |

| | | |
|-----------------------|--|--|
| Description | | Performance Competition Kettlebell |
| Specifications | | Made with steel outer bell painted in competition colours, and filled with sand & iron |
| Handle | | Steel handle |
| Increments | | 2kg increments up to 16kg, 4kg increments from 16kg to 32kg |
| Product Color | | Pink, blue, yellow, purple, green, orange, red |
| Warranty | | Limited 1 year warranty |

PERFORMANCE KETTLEBELL STORAGE RACK

The ZIVA® Performance Kettlebell Storage Rack brings to the gym an eye-catching display on which gyms can showcase ZIVA's precision-weighted bells. Crafted from 2mm thick steel tubing with tough PVC-lined shelves and a black powder-coated finish, the rack stores up to 10x kettlebells and helps keep them organized for quick changes during intense workouts.



| Order Code | Item Description |
|---------------|-------------------------------------|
| ZFT-KBRK-3699 | Performance Kettlebell Storage Rack |

| | | |
|-----------------------|--|---|
| Description | | Performance Kettlebell Storage Rack |
| Specifications | | Made with oval steel tubing, thick plate steel, welded frames, black- or chrome-colored hardware and PVC shelf lining |
| Color Options | | Black powder-coated finish |
| Storage | | Fits Up to 9x competition kettlebells |
| Dimensions | | 100cm x 60cm x 78cm - 37kg |
| Warranty | | Limited 5 year warranty on frames and welding, 1 year on plastic parts |









OLYMPIC BARS

ZIVA® Olympic Bars come in a wide array of shapes, sizes, weights, and capacities, allowing gym owners to customize their free weight sections to meet the specific needs of their clientele. All bars feature a premium hard chrome coating and grip-assisting knurling, capped ends for decreased maintenance needs, needle roller bearings for smooth rotation through all lifts, and they fit all Olympic-sized weight discs and clamp collars. Great bars are the building blocks from which great gyms are built, and ZIVA® Olympic Bars deliver the quality and dependability commercial gyms around the world have come to rely on.







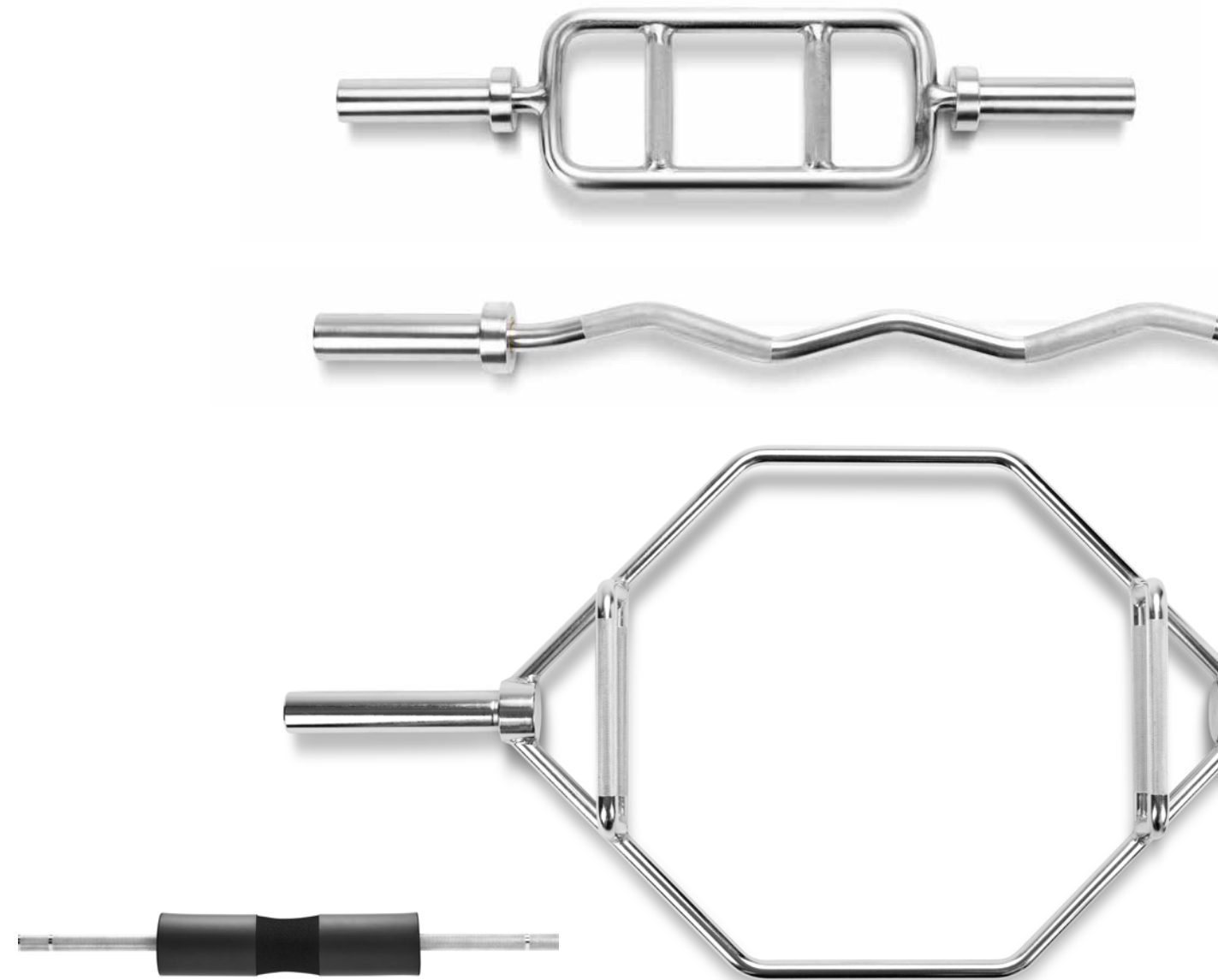

| Order Code | Item Description |
|------------------|--|
| ZFT-LBHC-2950-BK | Performance Olympic Black Oxide Bar 2.2m |
| ZFT-LBHC-2950-SV | Performance Olympic Chrome Bar 2.2m |
| ZFT-LBHC-2953-SV | Olympic Chrome Bar 1.8m |
| ZFT-LBHC-2954-SV | Olympic Chrome Bar 1.5m |

| | |
|-----------------------|---|
| Description |  Performance Olympic Bars |
| Specifications |  Made from alloy steel with either chromed or black oxide surface finish |
| Color Options |  <input checked="" type="checkbox"/> Black oxide <input type="checkbox"/> Chrome |
| Handle |  Knurled grips |
| Weight Loading |  Check the listings below for weight limits |
| Warranty |  Limited 1 year warranty |



| Order Code | Item Description |
|---------------|----------------------------------|
| ZFT-HCOB-2965 | Olympic Chrome Tricep Bar 76cm |
| ZFT-HCOB-2966 | Olympic Chrome EZ Curl Bar 1.2m |
| ZFT-PBHC-2936 | Olympic Chrome Hex Trap Bar 1.4m |
| ZFT-OBST-0373 | Olympic Spring Collar 100g |
| ZFT-OBCC-0436 | Olympic Clamp Collars |
| BFH-NSRL-0001 | Neck Support |



| | |
|-----------------------|---|
| Description |  Olympic Bars |
| Specifications |  Made from alloy steel with either chromed or black oxide surface finish |
| Color Options |  <input type="checkbox"/> Chrome |
| Handle |  Knurled grips |
| Weight Loading |  Check the listings below for weight limits |
| Warranty |  Limited 1 year warranty |



| | |
|-------------------------|-----------------------------------|
| Order Code | ZFT-LBHC-2950-BK/SV |
| Item Description | Performance Olympic Bar 7' |
| Weight | 20kg |
| Capacity | 331kg |
| Bar Diameter | 3cm |
| Length | 2.2m |
| Sleeve Length | 5cm diameter; 44.5cm long |



| | |
|-------------------------|------------------------------|
| Order Code | ZFT-LBHC-2953 |
| Item Description | Olympic Chrome Bar 6' |
| Weight | 16kg |
| Capacity | 150kg |
| Bar Diameter | 3cm |
| Length | 1.8m |
| Sleeve Length | 5cm diameter; 24cm long |



| | |
|-------------------------|------------------------------|
| Order Code | ZFT-LBHC-2954 |
| Item Description | Olympic Chrome Bar 5' |
| Weight | 13kg |
| Capacity | 150kg |
| Bar Diameter | 2.7cm |
| Length | 1.5m |
| Sleeve Length | 5cm diameter; 27cm long |



| | |
|-------------------------|---------------------------------------|
| Order Code | ZFT-HCOB-2965 |
| Item Description | Olympic Chrome Tricep Bar 30'' |
| Weight | 14kg |
| Capacity | 150kg |
| Bar Diameter | 2.5cm |
| Length | 76cm |
| Sleeve Length | 5cm diameter; 20cm long |



| | |
|-------------------------|--|
| Order Code | ZFT-HCOB-2966 |
| Item Description | Olympic Chrome EZ Curl Bar 47'' |
| Weight | 10kg |
| Capacity | 150kg |
| Bar Diameter | 3cm |
| Length | 1.2m |
| Sleeve Length | 5cm diameter; 20cm long |







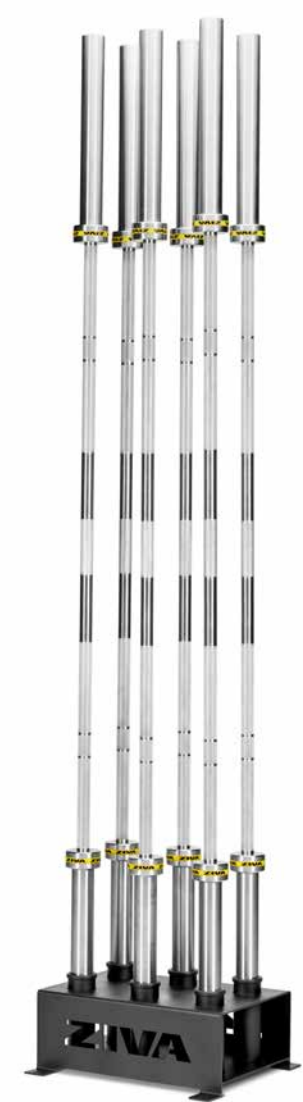

| | |
|-------------------------|---|
| Order Code | ZFT-PBHC-2936 |
| Item Description | Olympic Chrome Hex Trap Bar 55'' |
| Weight | 20kg |
| Capacity | 150kg |
| Bar Diameter | 3cm |
| Length | 1.4m |
| Sleeve Length | 5cm diameter; 56cm long |

PERFORMANCE OLYMPIC BAR RACK

The Olympic Bar may be the basis for any weight training program, but they can easily make a gym feel cluttered and disorganized without proper storage. The ZIVA® Performance Olympic Bar Rack, crafted with heavy-duty steel plate with scratch- and rust-resistant powder-coated finish, keeps up to 6x bars perfectly arranged in a vertical configuration that takes up minimum floor space for maximum efficiency.



| | |
|-------------------|---|
| Order Code | Item Description |
| ZFT-OBSS-5114 | Performance Olympic Bar Rack (6 pieces) |

| | | |
|-----------------------|---|--|
| Description |  | Performance Olympic Bar Rack |
| Specifications |  | Olympic Bar Rack made from steel plate |
| Color Options |  |  Black powder-coated finish |
| Storage |  | Fits up to 6 Olympic bars |
| Dimensions |  | 46cm x 40cm x 20cm - 15kg |
| Warranty |  | Limited 5 year warranty on frames and welding; 1 year on plastic parts |



ZIVA

5

5

ZIVA

ZIVA
5kg

PERFORMANCE HALF RACK

Our Performance Half Rack with tough 60mm laser cut steel frame and wide, stable base delivers much of the functionality of a wall- or floor-mounted rig without necessitating any additional installation. Users can push themselves to new limits on squat, bench press, overhead press, and more without worrying what will happen if they have to do a rough re-rack; this heavy-duty rack is made to withstand the rigors of elite training day in, and day out.



| Order Code | Item Description |
|--------------------|-----------------------------------|
| ZFT-RKHF-0690-BKGY | Performance Half Rack |
| ZFT-RGAT-1435 | Performance Safety Arm Attachment |

| | | |
|-----------------------|--|---|
| Description | | Performance Half Rack |
| Specifications | | Made with 70 x 70mm steel tubing 3mm thick, thick plate steel, welded frames, 20mm black-colored hardware |
| Product Color | | Black powder-coated finish |
| Dimensions | | 121cm x 140cm x 241cm - 75kg |
| Warranty | | Limited 10 year warranty on frames and welding; 1 year on plastic parts |

PERFORMANCE SLAM BALL

Full-body strength and endurance; intense, explosive cardio; and challenging rotational core exercises combine in one durable, elite-level tool guaranteed to push gym-goers' performance to its absolute limits. The ZIVA® Performance Slam Ball features a weighted, sand-filled center wrapped in a tough PVC shell with gripping tire tread skin, and is made to be thrown with abandon over and over again. For gyms focused on sport-specific training, HIIT and calisthenic workouts, or for trainers hoping to help clients attain a new level of physical fitness using unique and fun equipment and exercises, this tool offers a fantastic solution.



| Order Code | Item Description | Order Code | Item Description |
|--------------------|---------------------------|--------------------|----------------------------|
| ZFT-SPSB-6870-BKGY | Performance Slam Ball 2kg | ZFT-SPSB-6877-BKGY | Performance Slam Ball 9kg |
| ZFT-SPSB-6871-BKGY | Performance Slam Ball 3kg | ZFT-SPSB-6878-BKGY | Performance Slam Ball 10kg |
| ZFT-SPSB-6872-BKGY | Performance Slam Ball 4kg | ZFT-SPSB-6879-BKGY | Performance Slam Ball 12kg |
| ZFT-SPSB-6873-BKGY | Performance Slam Ball 5kg | ZFT-SPSB-6998-BKGY | Performance Slam Ball 14kg |
| ZFT-SPSB-6874-BKGY | Performance Slam Ball 6kg | ZFT-SPSB-6999-BKGY | Performance Slam Ball 16kg |
| ZFT-SPSB-6875-BKGY | Performance Slam Ball 7kg | ZFT-SPSB-6881-BKGY | Performance Slam Ball 18kg |
| ZFT-SPSB-6876-BKGY | Performance Slam Ball 8kg | ZFT-SPSB-6882-BKGY | Performance Slam Ball 20kg |







| | | |
|-----------------------|--|--|
| Description | | Performance Slam Ball |
| Specifications | | Made with hard-wearing PVC skin and sand and iron filler |
| Increments | | 1kg increments from 2-10kg and 2kg increments from 10-20kg |
| Product Color | | Black / Grey |
| Warranty | | Limited 1 year warranty |

PERFORMANCE MEDICINE BALL

One of history's oldest and most versatile fitness tools, the medicine ball has been used for centuries. The ZIVA® Performance Medicine Ball takes this timeless tool and brings it into the modern age with precision-calibrated weighting; premium-quality, easy-grip textured rubber; and vibrant, easy to ID numbering. This functional fitness legend is a must for any gym that wants to help users build explosive power; tone up muscles that twist and provide torque; and to create total-body strength for sport-specific training as well as general physical fitness.



| Order Code | Item Description | Order Code | Item Description |
|--------------------|-------------------------------|--------------------|--------------------------------|
| ZFT-CMMB-4670-BKGY | Performance Medicine Ball 1kg | ZFT-CMMB-4675-BKGY | Performance Medicine Ball 6kg |
| ZFT-CMMB-4671-BKGY | Performance Medicine Ball 2kg | ZFT-CMMB-4676-BKGY | Performance Medicine Ball 7kg |
| ZFT-CMMB-4672-BKGY | Performance Medicine Ball 3kg | ZFT-CMMB-4677-BKGY | Performance Medicine Ball 8kg |
| ZFT-CMMB-4673-BKGY | Performance Medicine Ball 4kg | ZFT-CMMB-4678-BKGY | Performance Medicine Ball 9kg |
| ZFT-CMMB-4674-BKGY | Performance Medicine Ball 5kg | ZFT-CMMB-4679-BKGY | Performance Medicine Ball 10kg |

| | | |
|-----------------------|---|--|
| Description |  | Performance Medicine Ball |
| Specifications |  | Made with premium rubber |
| Increments |  | 1kg increments |
| Product Color |  |  Black / Grey / White |
| Warranty |  | Limited 1 year warranty |

PERFORMANCE MEDICINE BALL/ SLAM BALL 5-PIECE STORAGE TREE

The ZIVA® Performance Storage Tree is both a storage solution and a beautiful display of elite-level functional training equipment. When paired with either the ZIVA® Performance Medicine Balls or Slam Balls, the Storage Tree becomes a functional fitness centerpiece. It features 5x steel tube cradles perfectly suited for storing various sizes of functional fitness equipment and has a sturdy frame made from 2mm thick steel tubing with long-lasting assembly hardware available in black or chrome.



Order Code ZFT-MDRK-6008-BK
Item Description Performance Medicine Ball/Slam Ball Tree (5 pieces)

| | | |
|-----------------------|--|---|
| Description | | Performance Medicine Ball/Slam Ball Storage Tree |
| Specifications | | Made with round steel tubing, welded frames, black or chromed coloured hardware |
| Product Color | | Black powder-coated finish |
| Storage | | Fits up to 5x medicine balls |
| Dimensions | | 56cm x 47cm x 154cm - 13kg |
| Warranty | | Limited 5 year warranty on frames and welding, 1 year on plastic parts |

PERFORMANCE MEDICINE BALL/ SLAM BALL 10-PIECE STORAGE TREE

The ZIVA® Performance 10-Piece Storage Tree is both a storage solution and a beautiful display of elite-level functional training equipment. When paired with either the ZIVA® Performance Medicine Balls or Slam Balls, both of which include 10x precision-calibrated balls, the Storage Tree becomes a functional fitness centerpiece. It features 10x steel tube cradles perfectly suited for storing various sizes of functional fitness equipment and has a sturdy frame made from 2mm thick steel tubing with long-lasting assembly hardware available in black or chrome.



Order Code ZFT-MDRK-6009-BK
Item Description Performance Medicine Ball/Slam Ball Tree (10 pieces)

| | | |
|-----------------------|--|---|
| Description | | Performance Medicine Ball/Slam Ball Storage Tree |
| Specifications | | Made with round steel tubing, welded frames, black or chromed coloured hardware |
| Product Color | | Black powder-coated finish |
| Storage | | Fits up to 10x medicine balls |
| Dimensions | | 101cm x 51cm x 163cm - 26kg |
| Warranty | | Limited 5 year warranty on frames and welding, 1 year on plastic parts |



PERFORMANCE POWER TWIST BAG

The ZIVA® Performance Power Twist Bag is a functional fitness classic that enables a range of squat and lunge related exercises to be performed quickly, making them perfect for functional fitness focused workouts. With high durability, reinforced PVC outer skin and a fiber core wrapped around its inner weighted sandbag, each one of these functional fitness powerhouses features sturdy nylon straps and PVC-skinned, grip-challenging handles so users train hands, grip, and wrists, but also continue past failure thanks to the straps. A well-rounded tool for hitting arms, shoulders, legs, and all rotational muscles, the Power Twist Bag is a great draw for functional fitness athletes.



| Order Code | Item Description |
|--------------------|----------------------------------|
| ZFT-FTBG-2194-BKGY | Performance Power Twist Bag 5kg |
| ZFT-FTBG-2195-BKGY | Performance Power Twist Bag 8kg |
| ZFT-FTBG-2196-BKGY | Performance Power Twist Bag 12kg |
| ZFT-FTBG-2197-BKGY | Performance Power Twist Bag 17kg |
| ZFT-FTBG-2198-BKGY | Performance Power Twist Bag 20kg |

| | | |
|-----------------------|--|---|
| Description | | Performance Power Twist Bag |
| Specifications | | Made with hard-wearing PVC outer skin and encapsulated sand-filled inner core |
| Color Options | | Black / Grey / White |
| Increments | | 4kg increments from 4kg - 12kg plus 17kg and 20kg |
| Warranty | | Limited 1 year warranty |

PERFORMANCE POWER SAND BAG

The ZIVA® Performance Power Sandbag is perfect for group training and teaching complex compound movements while also strengthening crucial stabilizer muscles. Made with a hard-wearing yet soft-to-the-touch polyester outer casing around a rubber-encased sand and metal filled center, these Bags offer a completely different kind of resistance that shifts throughout movements, making them the ideal challenge for functional fitness classes. Tough, high durability handles on all sides allow for greater versatility of movement so users can do even more with less.



| Order Code | Item Description | Order Code | Item Description |
|--------------------|-----------------------------------|--------------------|-----------------------------------|
| ZFT-SPPB-9950-BKGY | Performance Power Sand Bag 5kg | ZFT-SPPB-9954-BKGY | Performance Power Sand Bag 15kg |
| ZFT-SPPB-9951-BKGY | Performance Power Sand Bag 7.5kg | ZFT-SPPB-9955-BKGY | Performance Power Sand Bag 17.5kg |
| ZFT-SPPB-9952-BKGY | Performance Power Sand Bag 10kg | ZFT-SPPB-9956-BKGY | Performance Power Sand Bag 20kg |
| ZFT-SPPB-9953-BKGY | Performance Power Sand Bag 12.5kg | ZFT-SPPB-9957-BKGY | Performance Power Sand Bag 25kg |

| | | |
|-----------------------|--|---|
| Description | | Performance Power Sand Bag |
| Specifications | | Made from hard-wearing soft touch polyester outer casing and encased sand and metal filling |
| Color Options | | Black / Grey / White |
| Increments | | 2.5kg increments and 25kg |
| Warranty | | Limited 1 year warranty |

PERFORMANCE 8-PIECE STORAGE TREE

The ZIVA® Performance 8-Piece Storage Tree is both a storage solution and a beautiful display of elite-level functional training equipment. When paired with any set of ZIVA®'s precision-calibrated balls or bags, the Storage Tree becomes a functional fitness centerpiece. It features 8x steel tube cradles perfectly suited for storing various sizes of functional fitness equipment, has a sturdy frame made from 2mm thick steel tubing, and comes with long-lasting assembly hardware available in black or chrome.



Order Code ZFT-MDRK-6031-BK
Item Description Performance Storage Tree (8 pieces)

| | | |
|-----------------------|--|--|
| Description | | Performance Storage Tree |
| Specifications | | Made with oval steel tubing, welded frames, black or chromed coloured hardware |
| Color Options | | <input checked="" type="checkbox"/> Black powder-coated finish |
| Storage | | Fits up to 8x wall balls |
| Dimensions | | 85cm x 51cm x 147cm - 24kg |
| Warranty | | Limited 5 year warranty on frames and welding; 1 year on plastic parts |

PERFORMANCE 10-PIECE STORAGE TREE

The ZIVA® Performance 10-Piece Storage Tree is both a storage solution and a beautiful display of elite-level functional training equipment. When paired with any set of ZIVA®'s precision-calibrated balls or bags, the Storage Tree becomes a functional fitness centerpiece. It features 10x steel tube cradles perfectly suited for storing various sizes of functional fitness equipment, has a sturdy frame made from 2mm thick steel tubing, and comes with long-lasting assembly hardware available in black or chrome.



Order Code ZFT-MDRK-6028-BK
Item Description Performance Storage Tree (10 pieces)

| | | |
|-----------------------|--|--|
| Description | | Performance Storage Tree |
| Specifications | | Made with oval steel tubing, welded frames, black or chromed coloured hardware |
| Color Options | | <input checked="" type="checkbox"/> Black powder-coated finish |
| Storage | | Fits up to 10x wall balls |
| Dimensions | | 101cm x 51cm x 163cm - 26kg |
| Warranty | | Limited 5 year warranty on frames and welding; 1 year on plastic parts |



PERFORMANCE 4-TIER UNIVERSAL STORAGE RACK

The ZIVA® Performance 4-Tier Universal Storage Rack provides a spacious home for any and every kind of equipment. Whether it's medicine balls, kettlebells, dumbbells, core sandbags, or any other piece, this commercial quality storage solution keeps everything in its place. With its thick oval 2mm thick steel tubing, PVC-lined steel shelves, and durable scratch-resistant powder-coated finish, this functional furniture does double duty as display case and organizational tool that lends an elevated aesthetic.



Order Code
ZFT-MFSR-9885-BK

Item Description
Performance 4-Tier Universal Storage Rack

| | | |
|-----------------------|--|---|
| Description | | Performance 4-Tier Universal Storage Rack |
| Specifications | | Made with oval steel tubing, thick plate steel, welded frames, black- or chrome-colored hardware and PVC shelf lining |
| Color Options | | <input checked="" type="checkbox"/> Black powder-coated finish |
| Dimensions | | 82cm x 84cm x 166cm - 60kg |
| Warranty | | Limited 5 year warranty on frames and welding; 1 year on plastic parts |

PERFORMANCE 3-TIER, BALL STORAGE RACK

The ZIVA® Performance 3-Tier Ball Storage Rack features 3x shelves crafted from sturdy 2mm thick steel tubing that is specially crafted to hold balls of all shape and size. With a scratch-, wear-, rust-, and corrosion-resistant black powder-coating finish, this Ball Storage Rack can store up to 12x exercise balls of varying size and will stay looking fresh for years. It comes with 4x omnidirectional wheels so it can quickly and easily be moved anywhere in a gym, meaning classes and training can take place anywhere. This mobile organizational tool also serves as a display for these beautifully designed balls.



Order Code
ZFT-TBSR-7229-BK

Item Description
Performance 3 Tier Ball Storage Rack

| | | |
|-----------------------|--|---|
| Description | | Performance 3-Tier Ball Storage Rack |
| Specifications | | Made with round steel tubing, welded frames, black or chromed coloured hardware |
| Color Options | | <input checked="" type="checkbox"/> Black powder-coated finish |
| Storage | | Fits up to 12x small exercise balls |
| Dimensions | | 162cm x 55cm x 150cm - 34kg |
| Warranty | | Limited 5 year warranty on frames and welding; 1 year on plastic parts |

PERFORMANCE PLUS 4-TIER STORAGE RACK

The Performance PLUS 4-Tier Storage Rack is a storage and display piece that features swiveling wheels for quick, easy movement around the gym. This mobile storage and display rack carries functional fitness equipment of all kinds to target every body part, offering a comprehensive, full-body workout and it moves easily anywhere it's needed for quick, easy access to each piece. The 4-tiered rack is made from 2mm thick steel tubing and PVC-lined steel plate, is equipped with sturdy wheels. This all-in-one package makes it easy to move seamlessly from one personal training client to the next with minimal need for regathering or movement of equipment, so trainers can do more, faster, and with less effort.

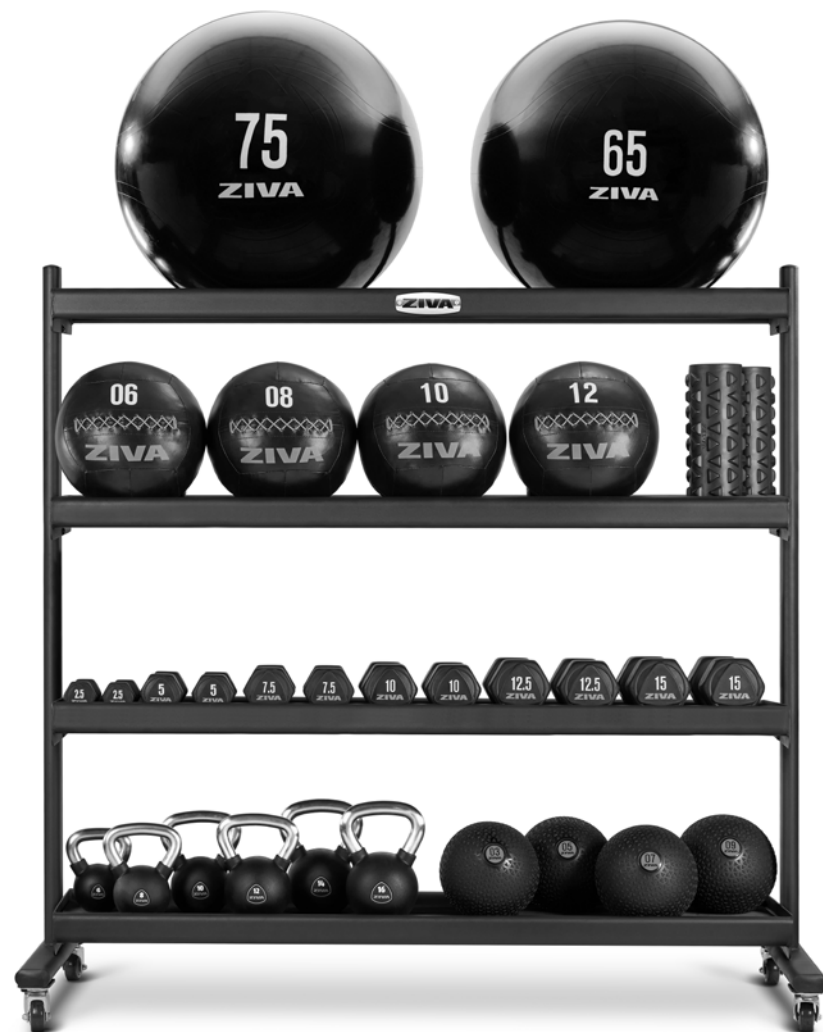

| Order Code | Item Description |
|-------------------|--------------------------------------|
| ZFT-MFSR-9648W-BK | Performance PLUS 4-Tier Storage Rack |

| | | |
|-----------------------|---|---|
| Description |  | Performance PLUS 4-Tier Storage Rack with Wheels |
| Specifications |  | Horizontal style frame, 3mm thick oval tube steel and wheeled base for easy portability |
| Color Options |  | <input checked="" type="checkbox"/> Black powder-coated finish |
| Dimensions |  | 182cm x 84cm x 178cm - 115kg |
| Warranty |  | Limited 5 year warranty on frames and welding; 1 year on plastic parts |



PERFORMANCE STUDIO BARBELL SET

The ZIVA Performance Studio Barbell Set includes everything needed for a Body Pump or similar workout. This complete set includes everything necessary to get started: a knurled, studio-size barbell with scratch- and corrosion-resistant chrome coating; precision-weighted RPU covered weight discs with an easy grip handle on either side; and super simple flip and lock clamp collars to guarantee a safe, secure workout. With this set, gyms are on their way to bringing members the sort of in-demand fitness classes that create communities around their brand.



| Order Code | Item Description |
|--------------------|--|
| ZFT-PRBS-7117 | Performance Weight Set RPU Disc 1.25kg |
| ZFT-PRBS-7118 | Performance Weight Set RPU Disc 2.5kg |
| ZFT-PRBS-7119 | Performance Weight Set RPU Disc 5kg |
| ZFT-PRBS-7483 | Performance Weight Set RPU Disc 10kg |
| ZFT-PRBS-7080-BKGY | ZIVA Performance Studio Barbell 19.5kg Set |
| ZVO-STCL-0438-BKGY | Studio Monster Clamp Collar |

| | | |
|-----------------------|--|---|
| Description | | Performance Studio Barbell |
| Specifications | | Discs made with premium rubberized polyurethane with cast core, chromed studio bar and PP collars |
| Handle | | Premium chrome handle |
| Increments | | 1.25kg, 2.5kg, and 5kg increments |
| Color Options | | Black / Grey / White |
| Warranty | | Limited 1 year warranty |

PERFORMANCE STUDIO BARBELL RACK

The Performance Studio Barbell Rack, with its capacity to hold up to 10x complete Studio Barbell sets, is the focal point of Body Pump and other similar group classes. Made from 2mm oval steel tubing and thick steel plate with a corrosion- and scratch-resistant black powder coat, this Rack is a grab-and-go station from which class participants can take everything they need so classes get started fast. All this high-quality equipment speaks with the same design language, as well, giving gyms a wonderful, unified premium aesthetic.



| Order Code | Item Description |
|------------------|--|
| ZFT-SB10-6005-BK | Performance 10-Set Studio Barbell Rack |

| | | |
|-----------------------|--|--|
| Description | | Performance Studio Barbell Rack |
| Specifications | | Made with oval steel tubing, thick plate steel, welded frames, black or chromed colored hardware |
| Color Options | | Black powder-coated finish |
| Storage | | Fits up to 10x performance studio barbells and plates |
| Dimensions | | 74cm x 54cm x 138cm - 26kg |
| Warranty | | Limited 5 year warranty on frames and welding, 1 year on plastic parts |

PERFORMANCE CABLE ATTACHMENTS

ZIVA® Performance Cable Attachments feature all the handles and bars necessary to make the absolute most out of a cable weight set up. Specialized bars for rowing and that allow for a wide variety of angles and grips; straight, angled, and bent bars especially made to help target triceps and biceps from several different positions; single- and double-sided rope attachments; and the classic stirrup handle and ankle strap. All bars are made with a scratch- and rust-resistant chrome finish and feature comfortable, long-lasting PU or TPE grips that give them a premium look and feel, while all straps are woven from high durability nylon.



| Order Code | Item Description | Order Code | Item Description |
|------------------|---|--------------------|---|
| ZXP-TCRB-6516-DG | 1 Performance Hard Chrome Short Lat Bar with PU Grip - 78cm | ZXP-MTBR-6514-DG | 8 Performance Hard Chrome Multi-Exercise Bar with PU Grip |
| ZXP-SRDH-6619-DG | 2 Performance Hard Chrome Seated Row Double Handle | ZXP-TCVR-6513-DG | 9 Performance Hard Chrome Bent Tricep Bar with PU Grip - 54cm |
| ZXP-LTBR-6509-DG | 3 Performance Hard Chrome Medium Lat Bar with PU Grip - 95cm | ZXP-ATCB-6620-DG | 10 Performance Hard Chrome Angled Tricep Bar with PU Grip |
| ZXP-LTBR-6511-DG | 4 Performance Hard Chrome Long Lat Bar with PU Grip - 120cm | ZXP-PLBR-6512-DG | 11 Performance Hard Chrome Short Lat Bar with PU Grip - 76cm |
| ZXP-TCSB-6616-DG | 5 Performance Hard Chrome Straight Tricep Bar with PU Grip - 43cm | ZXP-AKST-0228-BK | 12 Ankle Strap |
| ZXP-CBHD-6621-DG | 6 Performance Hard Chrome Stirrup Handle | ZXP-STCR-6510-BKGY | 13 Performance Single Rope |
| ZXP-PLBR-6518-DG | 7 Performance Hard Chrome Long Lat Bar with PU Grip - 96cm | ZXP-DTCR-6610-DG | 14 Performance Double Tricep Rope |
| | | ZXP-STHD-1437-BK | 15 Strap Handle |

| | | |
|-----------------------|--|-------------------------------------|
| Description | | Performance Cable Attachments |
| Specifications | | Assorted cable station attachments |
| Handle | | Premium chrome bars with TPE handle |
| Color Options | | Chrome with dark grey grips |
| Warranty | | Limited 1 year warranty |

PERFORMANCE CABLE ATTACHMENTS

When the entire Performance Cable Attachment set is sat alongside a cable weight station, the result is a total body resistance workout zone where any muscle group can be built from virtually any angle. A complete set makes the most use of a cable weight system, vastly enhances the usability of available gym space, and can potentially decrease the necessary number of equipment pieces needed for a fully rounded gym.

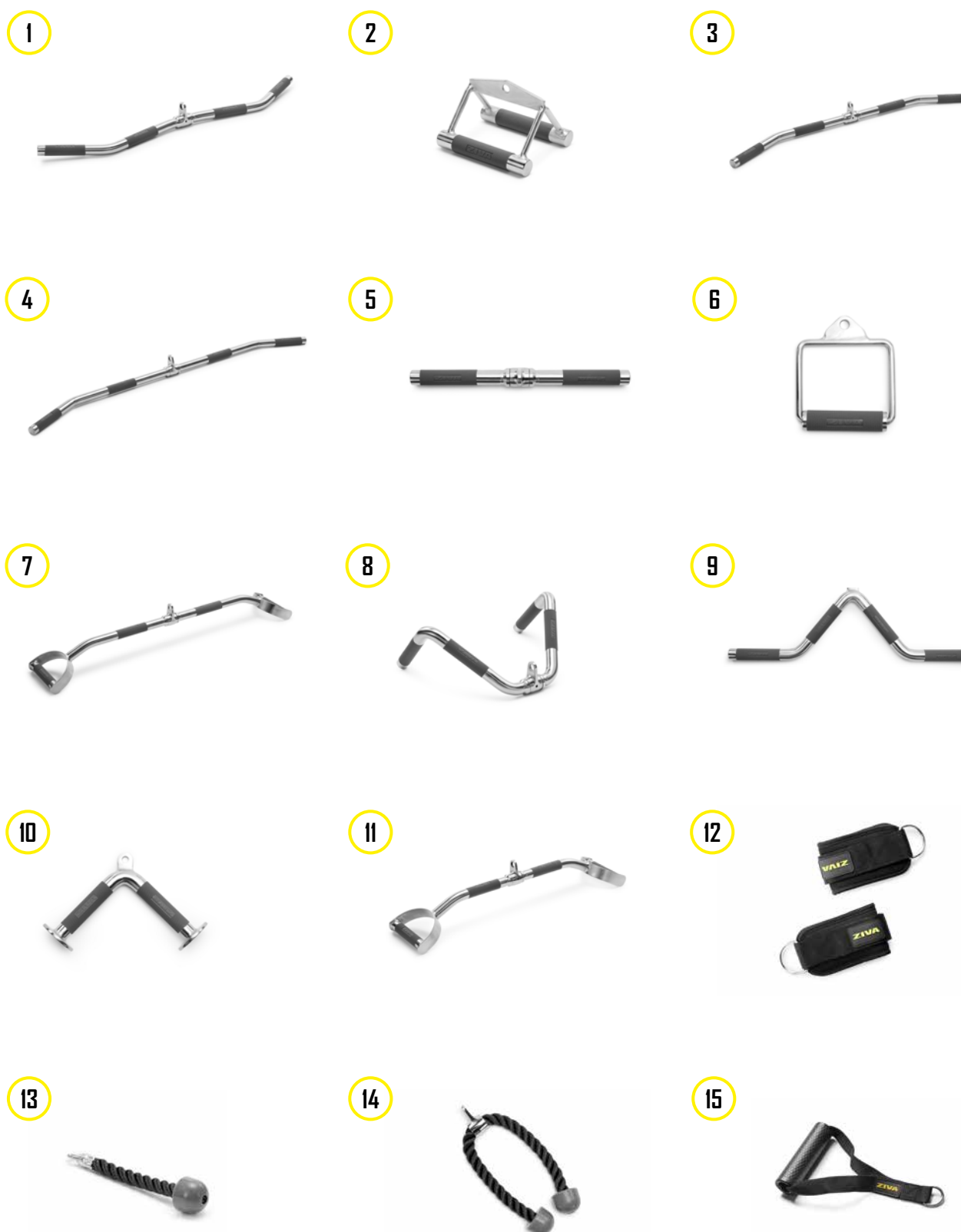

CABLE ATTACHMENT RACK

The ZIVA® Cable Attachment Rack is the perfect antidote to the seemingly inevitable clutter around every cable weight set up. Crafted from powder-coated thick plate steel and steel tubing with J-Cups to cradle all bar attachments, it has space enough to keep every variation of cable attachment stored, displayed, and optimally organized so users can find what they are looking for fast and the gym can stay looking fantastic.



Order Code

ZFT-CARK-0880

Item Description

Cable Attachment Rack (3 Tier)

| | | |
|-----------------------|---|--|
| Description |  | Cable Attachment Rack |
| Specifications |  | Made with oval steel tubing, thick plate steel, welded frames |
| Color Options |  |  Black powder-coated finish |
| Storage |  | Fits ZIVA cable attachments |
| Dimensions |  | 56cm x 52cm x 121cm - 35kg |
| Warranty |  | Limited 5 year warranty on frames, 1 year on plastic parts |

STUDIO MAT RACK WITH CASTERS

The ZIVA® Studio Mat Rack with Casters makes storage for classes easy and mobile. Crafted from steel tubing with a rust- and scratch-resistant black powder coat, this Mat Rack features holding pegs on both sides for enough storage space to cover classes of up to 20x participants, and comes with 4x PE wheels making movement anywhere and everywhere in the gym simple and easy.



| Order Code | Item Description |
|------------------|------------------------------|
| ZFT-MTRK-0198-BK | Studio Mat Rack with casters |
| ZFT-MTRK-0199 | Studio Mat Rack |

| | | |
|-----------------------|--|---|
| Description | | Studio Mat Rack with casters |
| Specifications | | Made with oval steel tubing, thick plate steel, welded frames, black or chromed colored hardware |
| Color Options | | Black powder-coated finish |
| Storage | | Fits ZIVA Yoga Mats with Eyelets |
| Dimensions | | 92.5 x 64 x 186.5cm - 19kg ZFT-MTRK-0198-BK (peg length - 196mm) ZFT-MTRK-0199 (peg length - 176mm) |
| Warranty | | Limited 5 year warranty on frames and welding, 1 year on plastic parts |

PERFORMANCE BOXING PUNCHING BAG / PERFORMANCE BOXING GLOVES

As a fun and challenging HIIT workout, boxing's popularity is on the rise and the ZIVA® Performance Boxing Punching Bag and Boxing Gloves deliver superior quality on all the essentials any gym needs to begin offering these intense, high energy workouts. The Performance Boxing Punching Bag is built tough with high durability premium synthetic leather skin and nylon strapping, and our Performance Boxing Gloves use the same premium quality, tough synthetic leather covering over a shock absorbing PU inner core. Whether for individual personal training or group boxing classes, together these pieces of equipment offer a premium package solution.



| Order Code | Item Description |
|---------------|---------------------------------|
| ZFT-MLPG-2572 | Performance Boxing Punching Bag |
| ZFT-MLBG-2577 | Performance Boxing Gloves |

| | | |
|-----------------------|--|---|
| Description | | Performance Boxing Punching Bag / Performance Boxing Gloves |
| Specifications | | - Performance Boxing Punching Bag is made with synthetic leather cover, nylon strapping, and mixed filler material - Performance Boxing Gloves are made with synthetic leather outer cover and PU inner core |
| Color Options | | Black / White |
| Warranty | | Limited 1 year warranty |







PERFORMANCE CORE-FIT BALL

Our Performance Core-Fit Ball makes core work easy. Added to any workout, it challenges users and increases recruitment of stabilizer muscles and maximizes muscle-building across the entire abdominal wall, easily and efficiently targeting the abs, obliques, and erectors. Designed with a non-slip, easy to grip surface and made with BPA-free PVC, the Performance Core-Fit Ball is tested up to 450kg, so workouts of any kind stay safe no matter how intense.



| Order Code | Item Description |
|------------------|---|
| ZFT-ABCB-9291-BK | Performance 55cm Core-Fit Ball |
| ZFT-ABCB-9270-BK | Performance 65cm Core-Fit Ball |
| ZFT-ABCB-9292-BK | Performance 75cm Core-Fit Ball |
| ZFT-YBST-2623-BK | Single Wall Mounted Anti-Burst Core-Fit Ball rack |

| | |
|-----------------------|--|
| Description |  Performance Core-Fit Ball |
| Specifications |  Made from heavy-duty and durable PVC |
| Color Options |  Black / White |
| Warranty |  Limited 6 month warranty |



PERFORMANCE SLED

For the functionally focused gym frequented by sport-specific training clientele, the ZIVA® Performance Sled is a crucial piece of equipment. Built to be ultra-durable, the sled consists of a steel frame and 4x exterior bars – two on each side so it can be pushed back and forth without having to turn it around – and a central loading bar, all with a wear-, rust-, and corrosion-resistant black powder-coating. The sled itself weighs 26kg and the central bar can fit up to 10x bumper plates for an intense full-body workout that develops users' legs, core, arms, shoulders, and explosivity.



Order Code
ZFT-PWSD-4016-BK

Item Description
Performance Sled

| | | |
|-----------------------|--|--|
| Description | | Performance Sled |
| Specifications | | Made with steel frame and bars |
| Color Options | | Black powder-coated finish |
| Storage | | Fits up to 10x bumper plates |
| Dimensions | | 86cm x 51cm x 91cm - 26kg |
| Warranty | | Limited 5 year warranty on frames and welding, 1 year on plastic parts |

XP SUSPENSION TRAINING SYSTEM 2.0

The pinnacle of functional fitness versatility has been upgraded for the 21st century. The ZIVA® XP Suspension Training System 2.0 improves on yesteryear's bodyweight trainer design with a range of innovative features. Front-facing forged steel cam buckles make on-the-fly length adjustments fast and easy; commercial-grade, certified steel carabiners with keylock noses allow easy attachment and removal of handles and anchor; and a reinforced strapping loop provides exceptional load-bearing capacity. The XP Suspension Training System 2.0 offers all the benefits of a traditional suspension trainer but with easier operation and added flexibility thanks to its unique, individually anchored handle strap design, allowing each handle to be anchored separately and opening up exponentially greater exercise variation and workout design options.



Order Code
ZXP-APUS-0588

Item Description
XP Suspension Training System 2.0

ZFT-WASK-6690-BK Performance Bodyweight Training Wall Anchor Kit

| | | |
|-----------------------|--|--|
| Description | | XP Suspension Training System 2.0 |
| Specifications | | Made with nylon strapping and with chrome & painted hardware |
| Color Options | | Black / Grey |
| Warranty | | Limited 1 year warranty |



ZIVA

ZIVA

05
ZIVA

10
ZIV

15
ZIVA

20
ZIVA

4
ZIVA

8
ZIVA

12
ZIVA

16
ZIVA

8
ZIVA

12
ZIVA

16
ZIVA

20
ZIVA

24
ZIVA

family love always

PERFORMANCE PLYO BOX

How do you deliver high-intensity high jumps with low risk and low impact? With the ZIVA® Performance Plyo Box. Our Plyo Box consists of a commercial-grade, high-durability anti-slip PVC skin that easily goes on and off of a PE foam core with underlying wooden platforms that athletes can set any of 3 ways for different intensities. Turn it one way, and it's a tough 20" step platform that works the calves, hamstrings, and glutes. Turn it another, and it's a high-intensity jump workout tool that challenges users to leap 24" into the air and land gracefully on its soft surface. Give it one more turn, and it demands users to soar to 30" up for workouts that build speed, explosivity, and power.



Order Code ZFT-TRPY-4014-BKGY
Item Description Performance Plyo Box

| Description | Icon | Item Description |
|----------------|------|---|
| Description | | Performance Plyo Box |
| Specifications | | Made from PE foam inner core, inner wooden platforms and with PVC outer coating |
| Color Options | | Black / Grey / White |
| Warranty | | Limited 1 year warranty |



PERFORMANCE WOODEN PLYO BOX

Built to withstand intense HIIT workouts at the high frequency of a commercial gym, the ZIVA® Wooden Plyo Box offers a satisfying, reverberating thud with each jump onto its stable, sturdy landing surface. Crafted from commercial-grade, high-durability composite plywood with a bonded exterior and beveled edges, this no-nonsense functional fitness mainstay offers 3 different intensities depending on which way it's turned. Whether at 50, 60, or 70cm, it delivers workouts that build speed, explosivity, and power with a head turning minimalist aesthetic.



Order Code
ZFT-PBWD-7233

Item Description
Performance Wooden Plyo Box

| | | |
|-----------------------|--|-----------------------------|
| Description | | Performance Wooden Plyo Box |
| Specifications | | Made from plywood |
| Color Options | | Natural brown |
| Dimensions | | 50cm x 60cm x 75cm |
| Warranty | | Limited 6 month warranty |

PERFORMANCE BATTLE ROPE

The ZIVA® Performance Battle Rope delivers both the perfect HIIT tool and a one-stop solution for complete upper body and core building workout. All of our Battle Ropes are built light enough to facilitate an exhaustive cardio workout for athletes, yet with the heft to build strength in shoulders, arms, back, and core. Woven from sturdy nylon with tough rubber handles, the Battle Rope is built to be rugged and durable enough to withstand the constant beating of the busiest studios.



Order Code
ZFT-BTRP-0912-BK
ZFT-BTRP-0913-BK
ZFT-BTRP-0914-BK
ZFT-BTRP-0915-BK
ZFT-RGAT-0987-BK

Item Description
Performance Battle Rope (5cm * 15m)
Performance Battle Rope (3.8cm * 10m)
Performance Battle Rope (3.8cm * 15m)
Performance Battle Rope (5.0cm * 10m)
Wall Mounted Battle Rope D-Handle Attachment

| | | |
|-----------------------|--|--|
| Description | | Performance Battle Rope |
| Specifications | | Made from hard-wearing nylon & PP rope and with a nylon cover, rubber handles and a steel ring |
| Color Options | | Black / Grey |
| Warranty | | Limited 1 year warranty |

ACCESSORIES



| Order Code | Item Description | Order Code | Item Description |
|------------------|---|--------------------|---|
| ZFT-FTAH-0556-YL | 1 Adjustable Hurdles 5 Pcs Set | ZFT-SBRT-0545-BKGY | 8 Performance Resistance Tube with Safety Sleeve Light |
| ZFT-FTAL-0512-YL | 2 Agility Ladder 15" Spacing | ZFT-SBRT-0546-BKGY | 9 Performance Resistance Tube with Safety Sleeve Medium |
| ZFT-FTAC-0488 | 3 Agility Cones & Carry Stand 30 pieces | ZFT-SBRT-0547-BKGY | 10 Performance Resistance Tube with Safety Sleeve Heavy |
| ZFT-FTAC-0464 | 4 Agility Cones & Carry Stand 15 pieces | ZFT-SBRT-0548-BKGY | 11 Performance Resistance Tube with Safety Sleeve Extra Heavy |
| ZFT-FPST-0179 | 5 Abs Pad | ZFT-DFRL-0274-BK | 12 Foam Roller |
| ZFT-PRLT-0430-BK | 6 Parallettes | ZFT-MPSS-1405-BK | 13 Multi-purpose straps |
| ZFT-SKRP-0531 | 7 Aluminum Speed Jump Rope | | |



ACCESSORIES



14



15



19



20



21



22



23



Order Code

ZFT-CRAW-0270

ZFT-LTBD-6595

ZFT-LTBD-6597

ZFT-LTBD-6598

ZFT-LTBD-6599

ZFT-MNBD-0429

Item Description

14 Abdominal Wheel

15 Performance Resistance Band Light

16 Performance Resistance Band Medium

17 Performance Resistance Band Heavy

18 Performance Resistance Band Extra Heavy

19 Loop Resistance Band Set (3 pieces)

ZFT-WDRS-7191

ZFT-DPBT-0284-BK

ZFT-OBLP-7843

ZFT-FPST-0190

20 Performance Wooden Rings Set

21 Dip Belt

22 Olympic Bar Landing Pads

23 ZVO Balance Pad



Our aspiration is to create a suite of products, content, and digital solutions that travel beyond functionality to inspiration, equipping athletes and enthusiasts with the means to achieve greatness.

ZIVA[®]

— THE WAY TO LIVE™ —

www.ziva.com

 [linkedin.com/zivastrength](https://www.linkedin.com/zivastrength)

 [instagram.com/zivastrength](https://www.instagram.com/zivastrength)

ZIVA Europe s.r.o Headquarters
Opletalova 1525/39, 110 00 Praha 1, CZECH REPUBLIC

EDC – European Distribution Center
Kojetinska 3151/73G, 750 02 Prerov, CZECH REPUBLIC